



EMC The easy way

Pocket-Guide

Introduction

The Committee for Electronic Binary and Analog Sensors of the ZVEI Division of Switching Devices, Switchboards and Industrial Controls has undertaken to elucidate the subject of EMC as it relates to specific products. A workgroup consisting of the following persons authored this booklet:

Peter Dolderer	(Balluff)
Reinhard Teichmann	(ifm)
Matthias Padelt	(Pepperl + Fuchs)
Oliver Bollian	(SEW)
Wolfgang Hussong	(Siemens)
Werner Thormann	(Turck)

distributed by

Division of Switching Devices, Switchboards and Industrial Controls of the ZVEI (German Electrical and Electronic Manufacturer's Association)
PO Box 70 20 61 · D-60591 Frankfurt am Main
Stresemannallee 19 · D-60596 Frankfurt am Main

Phone: +49 69 6302-398/399

Facsimile: +49 69 6302-386

E-Mail: schalt-tec@zvei.org

Chairman: Dr. Gunther Kegel

Manager: Dr. Helmut Sturm

The authors have prepared this pocket guide as an aid in dealing with EMC problems in industrial environments. This brochure describes in compact form the causes of EMC and recommended action countermeasures. It is intended as a tool for anyone involved with electrical interference, whether in electrical planning, construction of electrical systems or service.

This pocket guide makes use of practical situations and experience. Scientific precision is not intended. An easy-to-follow, uncomplicated representation of the topics has been chosen.

In spite of all due care in the preparation of this booklet, we cannot assume liability for its content.

Contents

Noise sources and receivers

Sensors / Actuators _____



Transmitters / Receivers _____



ESD _____



Frequency converters _____



Bus and field devices _____



Control cabinet design _____



Eliminating noise

Screening _____



High frequency grounding _____



Cable routing _____



Filters _____



Appendix

Terms _____



Sources _____



References _____



Sensors and Actuators



Noise susceptibility



Analog signal transmission



Capacitive sensors

Optical sensors



Inductive sensors



Network



Personal Computer



Aerial lines



Contactors

Mobile phones
Cellular phones



Broadcast transmitters

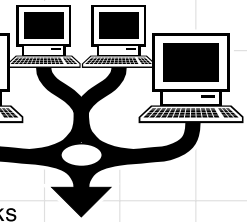

ks



Industrial robots



nters



Frequency converter
emits constant noise
signals unless preventive
measures are taken, but
it is itself relatively
unsusceptible

Frequency converters



Electric motors



Welding equipment

Noise potential



Transmitters / Receivers

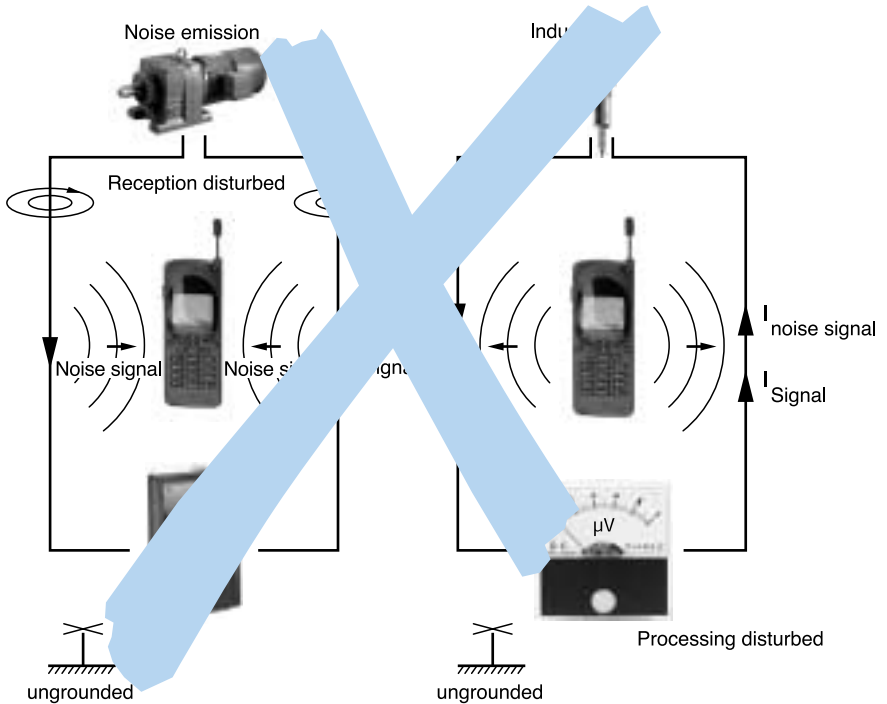

Faults

- No filtering
- Outgoing line and return line run separately
- No screening, no high frequency grounding

Problems

- Sporadically occurring malfunctions
- Measuring devices are affected
- Communications equipment is affected
- Devices and system components fail or malfunction
- Uneven control

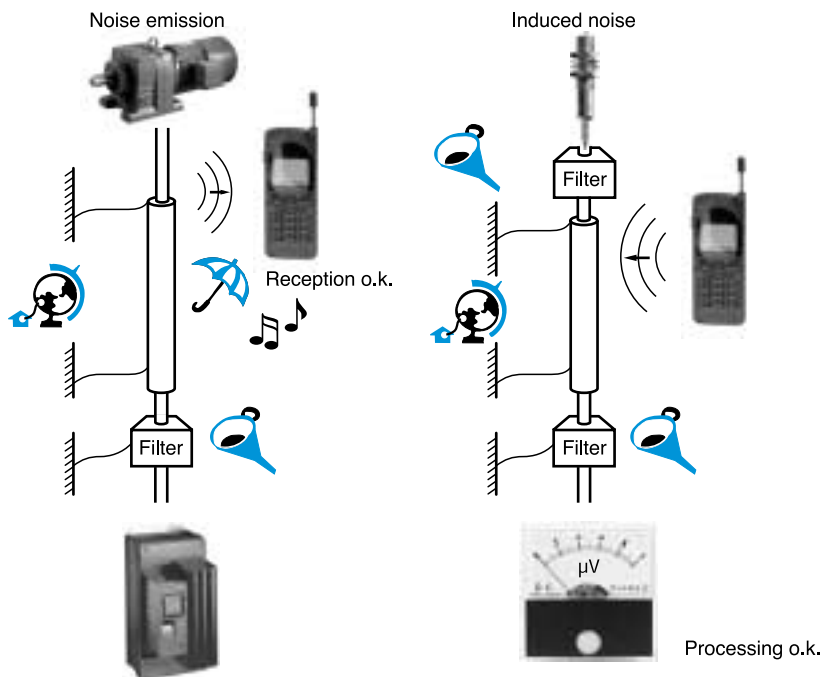

Checklist

- Lines as short as possible?
- Outgoing/return line run together?
- Screened cable used?
- Screen flat grounded?
- Filters installed?
- Filters flat grounded?

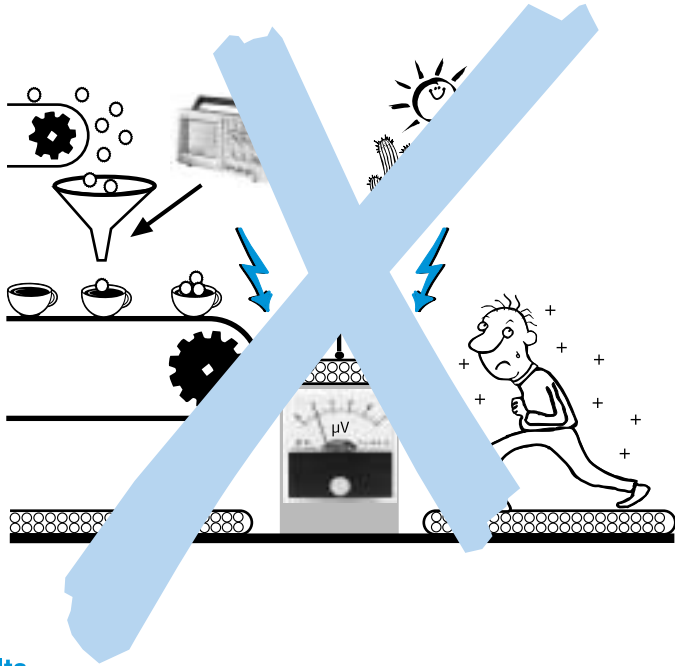

Faults

- Insulating floor coverings
- Dry air
- Insulating shoes
- Non-cotton clothing
- No grounding
- Non-conducting product

Problems

- Sporadically occurring malfunctions
- Measuring devices are affected
- Communications equipment is affected
- Devices and system components fail or malfunction
- Uneven control

Where do these problems occur?

- Conveyors
- Insulated belts run on metal rollers
- Insulating materials rub together
- Motion on insulated substrate
- Powder is ground, vibrated, transported

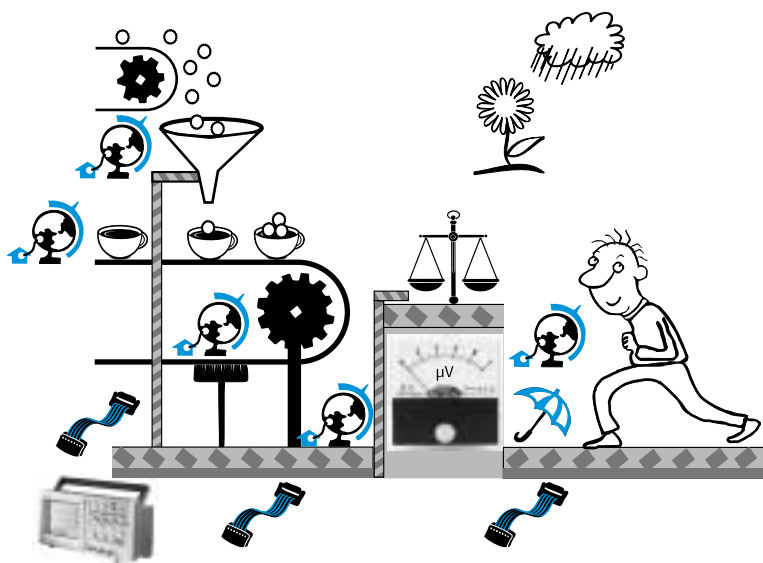

Checklist

- Are overvoltage (surge) protectors used?
- Are conductive floor coverings, work surfaces and containers used?
- Is there sufficient relative humidity?
- Are moving and fixed system parts grounded?
- Are metallic or conductive materials used?
- Is there provision for electrical discharge to non-critical areas (discharge path)?
- Suitable clothing, shoes, ESD equipment?

Frequency converters

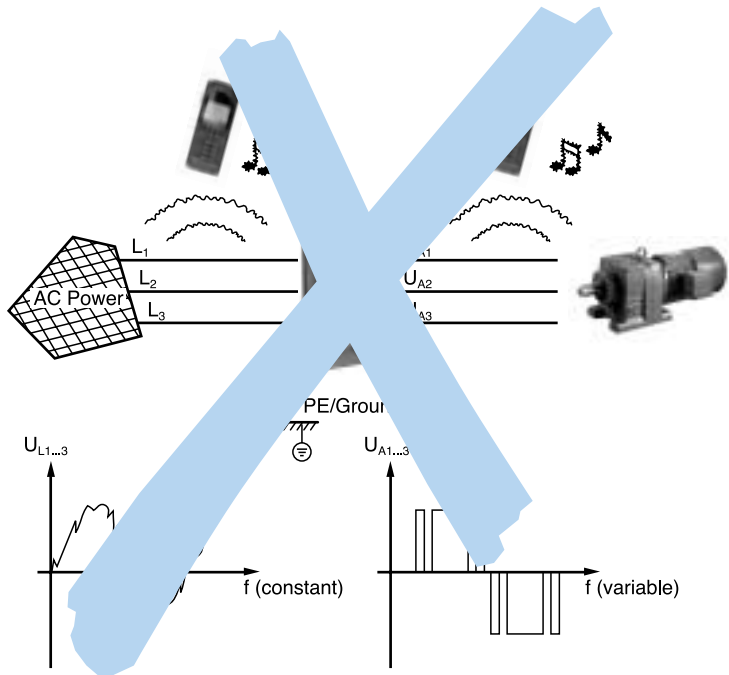

Faults

- Insufficient filtering
- Not an EMC-compliant installation
- No shielding
- No high frequency grounding

Problems

- Measuring devices are affected
- Communications equipment is affected
- Uneven control
- High-frequency noise signals are emitted by pulsed output voltage
- Frequency converters couple high-frequency noise into the power lines
- Other electrical devices powered by the high-voltage lines are disturbed
- High-frequency leakage currents to ground cause noise voltages in adjacent lines

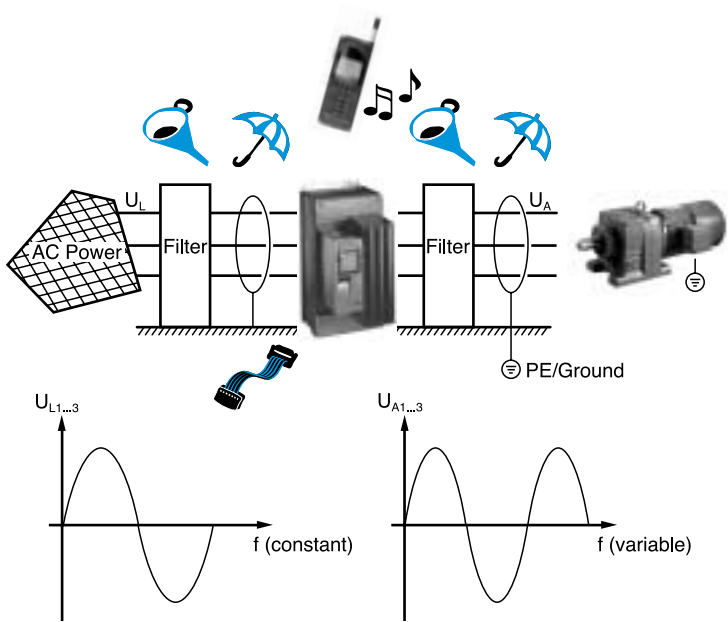

Checklist

- Are input power filters installed on the frequency converter (FC)?
- Is the output circuit of the FC equipped with a sinewave output filter?
- Are all cables shielded and as short as possible?
- Are all components and shields flat grounded to GND/PE?
- Are filters and the FC surface attached to the same control cabinet potential?

Bus and field devices

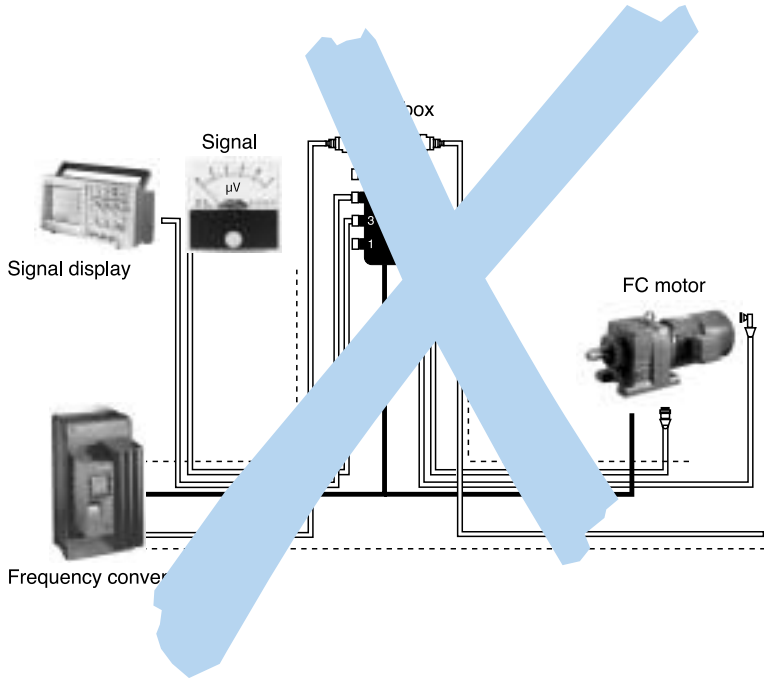

Faults

- No filtering
- Not an EMC-compliant installation
- No screening and no high frequency grounding
- Inappropriate cable routing

Problems

- Sporadically occurring faults
- Measuring devices are affected
- Communications equipment is affected
- Devices and system components malfunction or are destroyed
- Uneven control

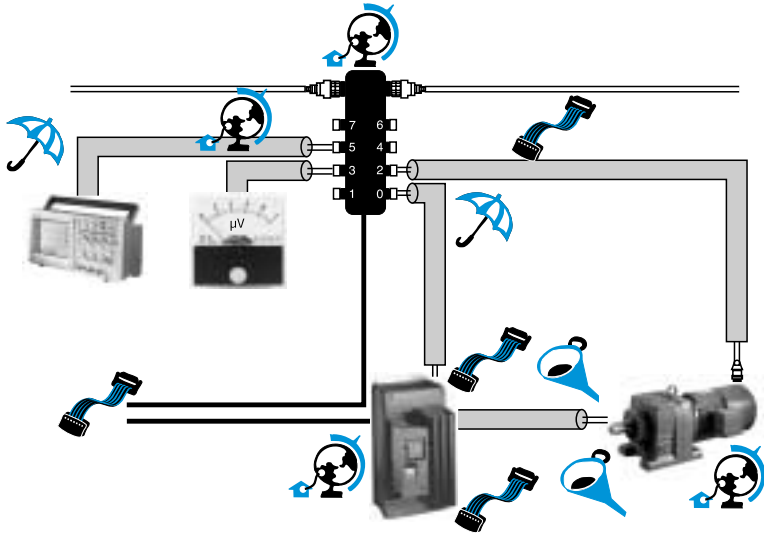

Checklist

- Suitable cable length, cable type, screening and topology?
- Termination resistors properly configured (both ends)?
- Transmission speed correctly chosen (cable length)?
- Fiber optic segments used in very noisy environment?
- Is grounding suitable for high frequency?
- Galvanic coupling avoided (no common return lines)?
- Ripple voltages accounted for?
- Potential equalization?
- Star arrangement of supply lines?
- Inductive components screened from magnetic fields?
- Sensitive lines routed separately and also protected (bus line can also be a noise source)?
- Correct cable routing observed (distance between individual susceptibility classes)?

Control cabinet design

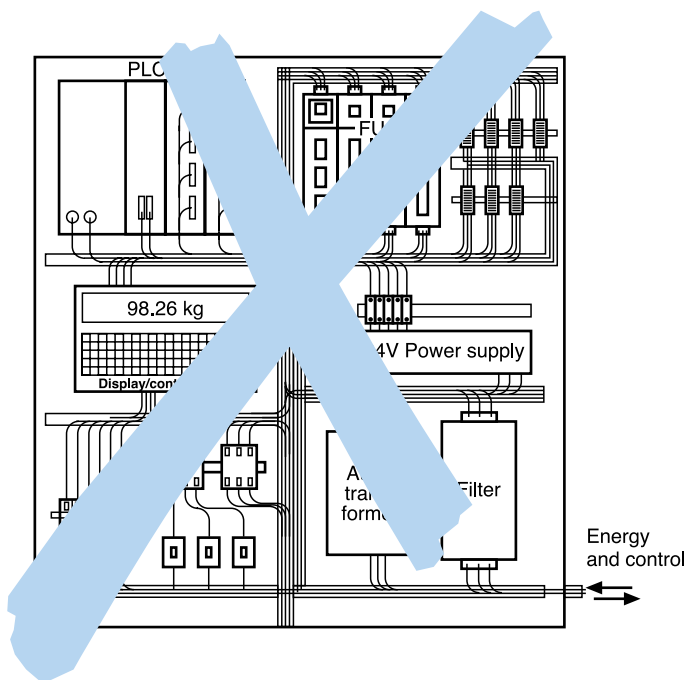

Faults

- Not an EMC-compliant installation
- Outgoing and return lines routed separately
- No screening and no high frequency grounding
- Chaotic cable routing
- No HF-compatible connection of metal housing parts

Problems

- Sporadically occurring faults
- Measuring devices are affected
- Communications equipment is affected
- Devices and system components malfunction or are destroyed
- Uneven control
- High-frequency noise signals are emitted by pulsed output voltage
- Frequency converters couple high-frequency noise into the power lines
- Other electrical devices powered by the high-voltage lines are disturbed
- High-frequency leakage currents to ground cause noise voltages in adjacent lines

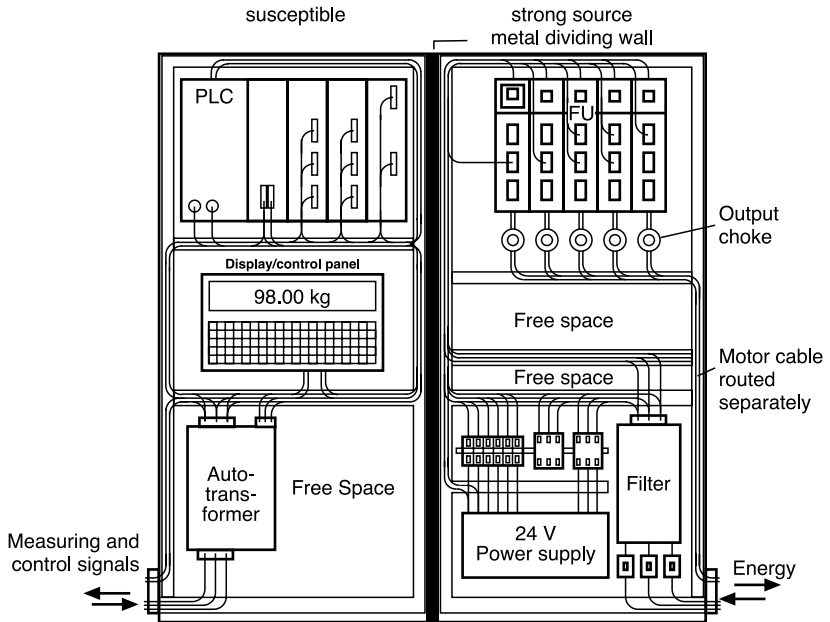

Checklist

- EMC control cabinet planning followed?
- Separate cabinets for power electronics and low-voltage signals where possible?
- Dividing walls contacted all-round?
- Mounting plate EMC-compliant (not painted or anodized)?
- Ground rails have low ohmic connection to mounting plate?
- Cables from different cable groups physically separated?
- Noise-generating and susceptible cables crossed at right angles?
- Cable screens grounded at cabinet entry and exit and to the devices?
- Filters correctly installed?
- Fluorescent displays located sufficiently away from sensitive devices?

Screening



metallic
cable duct

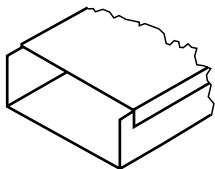

metallic
cable tray

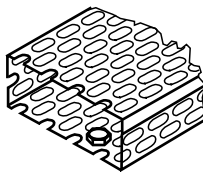

plastic
cable duct

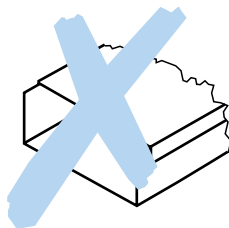

using the screen effect -
install cables without screen near
to the corners of cable tray

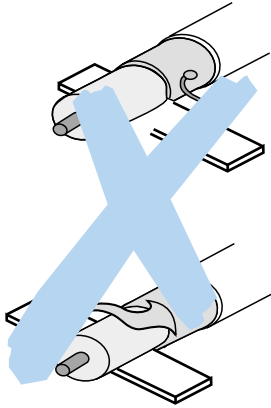

no pigtails

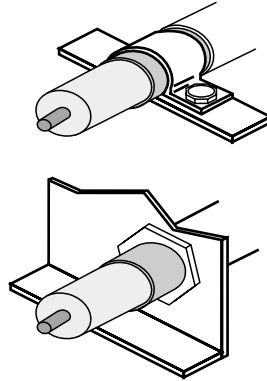

The cable screen shall be continuous from the transmitter to the receiver. All the earthing connections should be as short as possible. Screen should be earthed on both ends

In case of the plastic enclosures the screening should continuous through an adequate screen connection

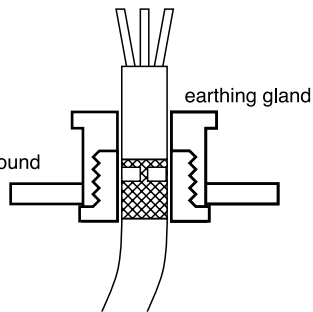
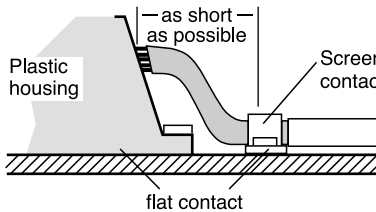

Checklist

- Screened cables used?
- EMC qualified cable glands?
- Metallic cable ducts for unscreened cables?
- Attention paid to cable path way?
- Screen of running cables earthed several times?



Not equipotential bonding over the screen!

High frequency grounding



High frequency grounds are not equal to safety grounds according to VDE 0100! EMC ground connectors provide only secondary protection against dangerous contact voltages.

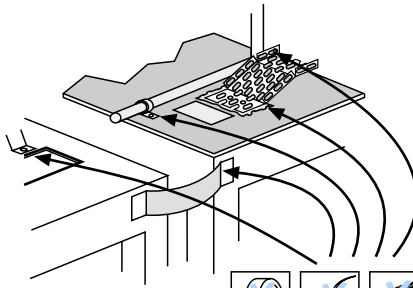

not insulated grease-free unpainted

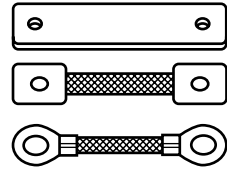

Typical connectors for proper potential equalization have large surface areas and cross-section.

Better to use weld connections than screw connections (no corrosion). Short connections, ground straps and preferable to round wires.

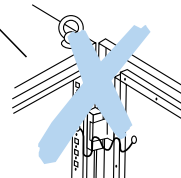
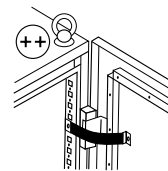
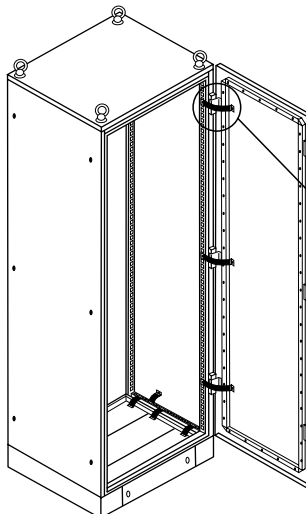

Low ohmic control cabinet elements connections for high frequencies

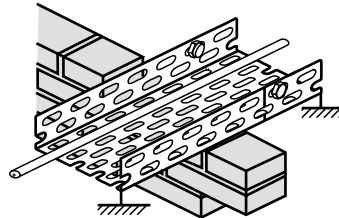
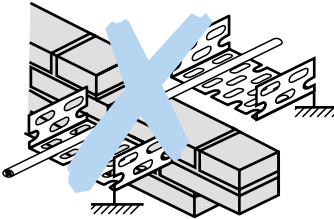
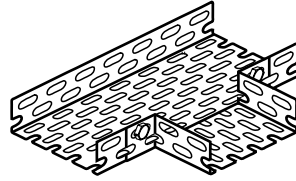
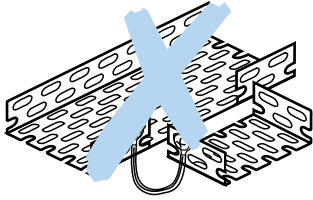

Incorporate metal cable ducts into the ground network and connect all the way through



Checklist

- VDE 0100 followed?
- Contact points bare and grease-free?
- All components tied to the same ground?
- Can HF compensation currents flow back through frame parts with low enough resistance?
- Are compensation currents prevented from flowing through shields?
- Are metal cable ducts and components included in the ground network?
- Are all electrical components routed separately (star configuration) to the potential equalization?

Cable routing

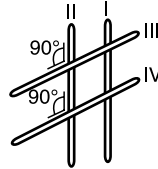
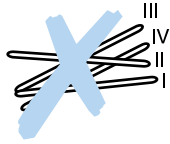

Cross lines from Group I, II and III, IV at right angles

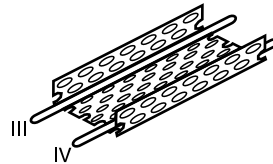
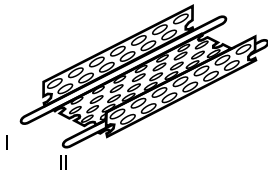

Ideal: Route cables in separate cable ducts

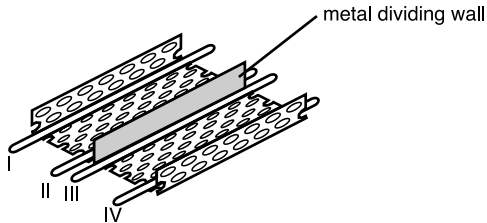

Alternate: Separate lines using metal rail

Cable routing plays a large role in the EMC suitability of an installation.

The cables should be divided into four groups: I, II, III and IV

Group I: Very susceptible (analog signals, instrument lines)

Group II: Susceptible (digital signals, sensor cables, 24VDC switching signals, communications signals, e.g. field buses)

Group III: Noise source (control cable for inductive loads, unswitched power cables, motor brakes, contactors)

Group IV: Strong noise sources (output cables from frequency converters, supply cables for welding equipment, switched power cables)

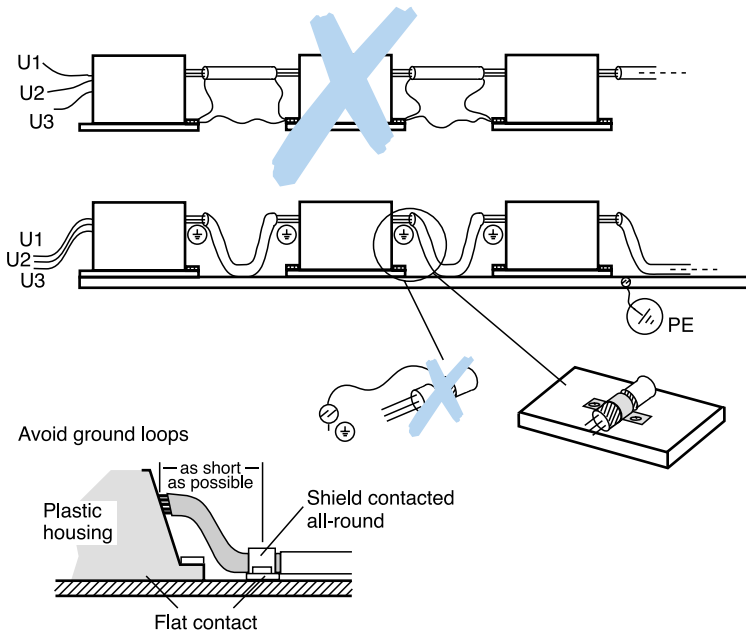

Checklist

- Noise carrying and susceptible cable properly grouped?
- ... and never routed in the same cable tree?
- Distance between noise carrying and susceptible cables >10 cm?
- Do noise carrying and susceptible cables cross at right angles?
- Are noise carrying cables shielded?
- Are metal cable ducts with dividers used?
- Are metal cable ducts connected to each other and to high frequency ground with full contact?
- Are unshielded cables routed in the corners of metal cable ducts?
- Are long shielded cables grounded at multiple points?
- Are shielded cables grounded at both ends?
- Are unused cables grounded at both ends?
- Are outgoing and return lines routed together over the entire length?
- Is the shield tied to high frequency ground near the housing for plastic housings?
- All connection cables straight (not bundled)?

Filters

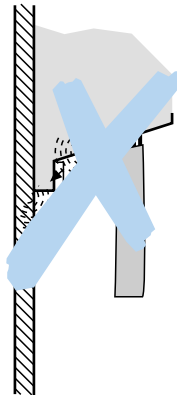
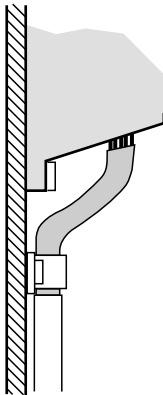
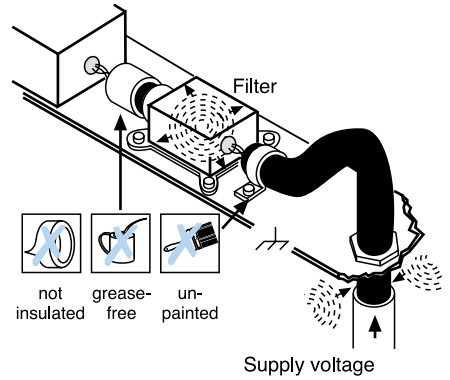
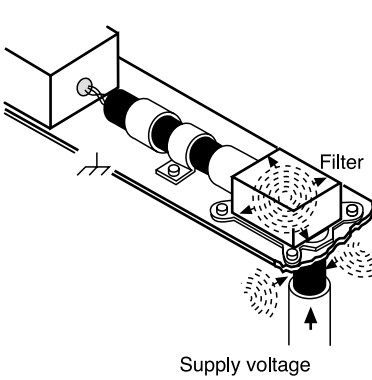
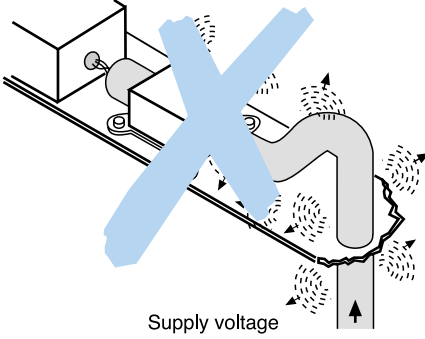

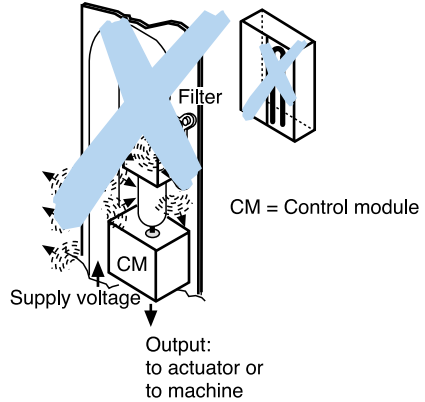
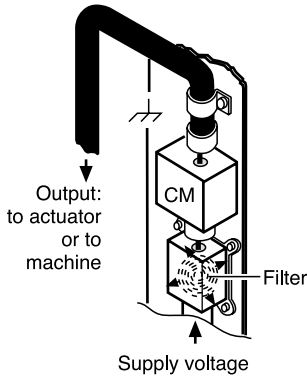

Checklist

- Permissible current and voltage for the filter ok?
- Filter with leakage current $>3.5\text{mA}$ firmly connected?
- Frequency range noted?
- Are power conditioners located directly on the input of the device?
- Output filters on the motor side located directly on the output?
- Filters directly mounted to the metal reference potential?
- Are filters grounded with large surface area?
- Was paint removed from the housing before attaching the filter?
- Are screened cables grounded directly at the filter?
- Are coupling between in- and output lines prevented?
(do NOT route in- and output cables parallel to each other)
- Is screened cable used between the filter and FC?
- Are cables routed directly over the metal reference potential?
- Is the screen tied to high frequency ground near the housing for plastic housings?
- All connection cables straight (not bundled)?

Terms

A-Z

Data telegram

A series of levels organized according to a specification which as a whole contain useful information that can be sent over a transmission medium.

EMC

Electromagnetic Compatibility.

Requirements for the devices:

- The generation of electromagnetic noise must be limited such that radio and telecommunication devices as well as other devices can operate within design tolerances.
- The ability of a system or equipment to operate within design tolerances in its intended environment, with adjacent systems and equipment, and with itself.

ESD

Electrostatic Discharge

A transfer of electrostatic charge between bodies at different electrostatic potentials caused by direct contact or induced by an electrostatic field.

Ferrite ring core

Sintered metal oxides with good magnetic characteristics, used to reduce the harmonic component of HF currents, see also output choke.

Fiber optics

Light conductor, optical transmission medium typically made of plastic or glass fibers.

Field buses

A communication connection for networking sensors and actuators (e.g. Profibus, Interbus, AS-Interface).

Galvanic coupling – high frequency

Terms used in high frequency technology and HF physics.

High frequency grounding

Proper high frequency-compatible grounding such that the HF currents can flow to ground. The existing safety ground should not be used as a high frequency ground.

Leakage current

Current that flows from cables or devices to ground by means of parasitic capacitance.

Output choke

Used to reduce the noise level of the output cable. The choke together with parasitic capacitance forms a low-pass filter which rounds off the square pulses of the output voltage.

Output filter

Used for noise suppression, noise filtering and to reduce leakage current spikes with group drives. The sinewave output filter creates an essentially sinusoidal voltage

from the squarewave pulses of the output voltage.

Power conditioner

Used to filter noise voltages from and to the mains.

Safety ground

Grounding in accordance with VDE100 to protect against dangerous contact voltages.

Sinewave filter

See also "output filter"

Termination resistor

In order to prevent reflections (echoes), defined terminations in the form of resistors are connected at the front and back end of a bus line.

Sources



- "Praxis in der Antriebstechnik" Vol. 9: EMV in der Antriebstechnik; SEW-Eurodrive, Bruchsal
- "Rittal Praxis-Tips zur Montage": EMV-gerechter Schaltschrankaufbau; Rittal, Herborn

References



- Schwab, Adolf "Elektromagnetische Verträglichkeit", Springer-Verlag Heidelberg
- Durcansky, Georg "EMV-gerechtes Gerätedesign", Franzis-Verlag München
- Gonschorek, Karl-Heinz; Singer, Hermann "Elektromagnetische Verträglichkeit - Grundlagen, Analysen, Maßnahmen", Teubner-Verlag Stuttgart
- Zeitschrift "EMC Journal" KM Verlagsgesellschaft München

AMI-Elektronik GmbH & Co. Produktions KG,
Puchheim

Bernstein AG,
Porta Westfalica

CARLO GAVAZZI GmbH,
Weiterstadt

DR. JOHANNES HEIDENHAIN GmbH,
Traunreut

EUCHNER GmbH + Co.,
Leinfelden-Echterdingen

FRABA Sensorsysteme GmbH,
Köln

Fritz Kübler GmbH,
Villingen-Schwenningen

Gebhard Balluff GmbH & Co.,
Neuhausen

Hans Turck GmbH + Co. KG,
Mülheim

Hengstler GmbH,
Aldingen

Honeywell AG,
Offenbach

HÜBNER ELEKTROMASCHINEN AG,
Berlin

ifm electronic gmbh,
Essen

K.A. SCHMERSAL GMBH & CO.,
Wuppertal

Klaschka GmbH & Co.,
Tiefenbronn

Lenord, Bauer & Co GmbH,
Oberhausen

Leuze electronic GmbH + Co.,
Owen

LTN Servotechnik GmbH,
Unterföhring

Matsushita Electric Works (Europe) AG,
Holzkirchen

Max Stegmann GmbH,
Donaueschingen

OMRON ELECTRONICS GmbH,
Langenfeld

Pepperl + Fuchs GmbH,
Mannheim

PULSOTRONIC MERTEN GmbH & Co.KG,
Wiehl

RECHNER Industrie-Elektronik GmbH,
Lampertheim

SCHALLER-AUTOMATION
Industrielle Automationstechnik KG,
Blieskastel

SEW-Eurodrive,
Bruchsal

Schneider Electric GmbH,
Ratingen

Sick AG,
Waldkirch

SIEMENS AG,
Erlangen

Thalheim-Tachometerbau GmbH & CO.KG,
Eschwege

TR Electronic GmbH,
Trossingen

TWK Elektronik GmbH,
Düsseldorf

VISOLUX Elektronik GmbH,
Berlin