

Axial kits EAMM-A

FESTO



Festo core product range
Solves the majority of your automation tasks

Worldwide:
Superb:
Easy:

Always in stock
Festo quality at an attractive price
Simplified procurement and warehousing

★ Generally ready for shipping ex works in 24 hours
In stock at 13 Service Centres worldwide
More than 2200 products

★ Generally ready for shipping ex works in 5 days
Assembled for you at 4 Service Centres worldwide
Up to 6×10^{12} variants per product family

Just look
for the
star!

Key features

At a glance

The following kits are used for force-locked coupling of motors and axes. The couplings transmit the drive energy of the motor to the axes. They can be connected to Festo motors or third-party motors.

The selection provides you with an overview of possible combinations. The planning tool "PositioningDrives" helps you find the right combination.

"PositioningDrives" planning tool for electric drives in connection with Festo motors

Simply enter a few application details and PositioningDrives will calculate the ideal combination from the widely coordinated range of electromechanical linear drives, motors, gear units and controllers.



Find the right axis/motor combination with third-party motors fast

Select the required axis and note the code in the "Motor interface" column.

Look for the interface code in the interface table for third-party motors (→ from page 58) and check if the desired third-party motor is listed.



Motorcode	Motorcode	Motorcode
ESM 32	10	10
ESM 40	11	11
ESM 50	12	12
ESM 63	13	13
ESM 80	14	14
ESM 100	15	15
ESM 125	16	16
ESM 160	17	17
ESM 200	18	18
ESM 250	19	19
ESM 315	20	20
ESM 400	21	21
ESM 500	22	22
ESM 630	23	23
ESM 800	24	24
ESM 1000	25	25
ESM 1250	26	26
ESM 1600	27	27
ESM 2000	28	28
ESM 2500	29	29
ESM 3150	30	30
ESM 4000	31	31
ESM 5000	32	32
ESM 6300	33	33
ESM 8000	34	34
ESM 10000	35	35
ESM 12500	36	36
ESM 16000	37	37
ESM 20000	38	38
ESM 25000	39	39
ESM 31500	40	40
ESM 40000	41	41
ESM 50000	42	42
ESM 63000	43	43
ESM 80000	44	44
ESM 100000	45	45
ESM 125000	46	46
ESM 160000	47	47
ESM 200000	48	48
ESM 250000	49	49
ESM 315000	50	50
ESM 400000	51	51
ESM 500000	52	52
ESM 630000	53	53
ESM 800000	54	54
ESM 1000000	55	55
ESM 1250000	56	56
ESM 1600000	57	57
ESM 2000000	58	58
ESM 2500000	59	59
ESM 3150000	60	60
ESM 4000000	61	61
ESM 5000000	62	62
ESM 6300000	63	63
ESM 8000000	64	64
ESM 10000000	65	65
ESM 12500000	66	66
ESM 16000000	67	67
ESM 20000000	68	68
ESM 25000000	69	69
ESM 31500000	70	70
ESM 40000000	71	71
ESM 50000000	72	72
ESM 63000000	73	73
ESM 80000000	74	74
ESM 100000000	75	75
ESM 125000000	76	76
ESM 160000000	77	77
ESM 200000000	78	78
ESM 250000000	79	79
ESM 315000000	80	80
ESM 400000000	81	81
ESM 500000000	82	82
ESM 630000000	83	83
ESM 800000000	84	84
ESM 1000000000	85	85
ESM 1250000000	86	86
ESM 1600000000	87	87
ESM 2000000000	88	88
ESM 2500000000	89	89
ESM 3150000000	90	90
ESM 4000000000	91	91
ESM 5000000000	92	92
ESM 6300000000	93	93
ESM 8000000000	94	94
ESM 10000000000	95	95
ESM 12500000000	96	96
ESM 16000000000	97	97
ESM 20000000000	98	98
ESM 25000000000	99	99
ESM 31500000000	100	100

Overview of interfaces

Axis mechanism interface	
D19	EGSL-35
D32	ESBF-32, EGSL-45, ERMB-20, EHMB-20
D32-35A	ERMB-20, EHMB-20
D40	ESBF-40, EGSL-55, ERMB-25, EHMB-25
D50	ESBF-50
D60	ESBF-63, EGSL-75, ERMB-32, EHMB-32
D80	ESBF-80
D100	ESBF-100
L27	EGC-50-...-TB
L38	EGC-70-...-TB
L48	EGC-80-...-TB
L62	EGC-120-...-TB
L95	EGC-185-...-TB
M43	EGC-HD-125-...-TB
M48	EGC-HD-160-...-TB
M80	EGC-HD-220-...-TB
N38	ELGA-TB-...-70
N48	ELGA-TB-...-80, ELCC-TB-...-60, ELCC-TB-...-70
N80	ELGA-TB-...-120, ELCC-TB-...-90
L95	ELGA-TB-...-150, ELCC-TB-...-110
P3-28D	EGSK-15
P4-28B	EGSK-20
P5-28B	EGSK-26
P6-38A	EGSK-33
P8-38A	EGSK-46
R27	ELGG-...-35, ELGR-...-35
R38	ELGG-...-45, ELGR-...-45
R48	ELGG-...-55, ELGR-...-55
S38	EGC-70-...-BS, EGC-HD-125-...-BS, ELGA-BS-...-70
S48	EGC-80-...-BS, EGC-HD-160-...-BS, ELGA-BS-...-80
S62	EGC-120-...-BS, EGC-HD-220-...-BS, ELGA-BS-...-120
S95	EGC-185-...-BS, ELGA-BS-...-150
V20	EPCC-25, EGSC-25
V25	EPCC-32, EGSC-32, ELGC-BS-32
V32	EPCC-45, EGSC-45, ELGC-BS-45, ELGC-TB-45
T42	EPCC-60, EGSC-60, ELGC-BS-60, ELGC-TB-60
T46	ELGC-BS-80, ELGC-TB-80, ELGT-BS-90/-120/-160

Motor interface	
28A	Stepper motor EMMS-ST-28
28AA	Third-party motor
38AA	Third-party motor
40A	Third-party motor
40G	Gear unit EMGA-40, EMGC-40, third-party gear unit
40P	Servo motor EMME-AS-40, third-party motor
40R	Third-party motor

40RA	Third-party motor
42A	Stepper motor EMMS-ST-42, third-party motor
42AB	Third-party motor
50GA	Third-party motor
55A	Third-party motor
57A	Stepper motor EMMS-ST-57
57AA	Third-party motor
58AA	Third-party motor
60AA	Third-party motor
60AB	Third-party motor
60G	Gear unit EMGA-60-...-SAS/SST, third-party gear unit
60H	Gear unit EMGA-60-...-EAS, EMGC-60, third-party motor
60P	Servo motor EMMT-AS-60, EMME-AS-60, third-party motor
60PA	Third-party motor
60R	Third-party motor
60RA	Third-party motor
67A	Integrated drive EMCA-EC-67
70A	Third-party motor
70AA	Third-party motor
70GA	Third-party gear unit
80G	Gear unit EMGA-80, third-party gear unit
80P	Servo motor EMME-AS-80, third-party motor
80PA	Third-party motor
80PB	Third-party motor
82AA	Third-party motor
84AA	Third-party motor
85AA	Third-party motor
87A	Stepper motor EMMS-ST-87
90GA	Third-party motor
100A	Servo motor EMME-AS-100, third-party motor
120G	Gear unit EMGA-120-...-SAS, third-party gear unit
140A	Servo motor EMMS-AS-140
160G	Gear unit EMGA-160-...-SAS, third-party gear unit
190A	Servo motor EMMS-AS-190

Product range overview

Permissible axis/motor combinations with electric cylinder EPCC

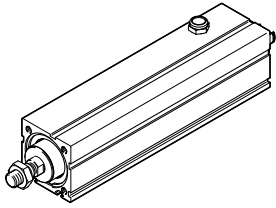

Table of interfaces for third-party motors

→ from page 58

Technical data for axial kits

→ from page 62

Motor ¹⁾ Type	Motor interface	Axial kit	
		Part no.	Type
EPCC-25			
With stepper motor			
EMMS-ST-28-...	28A	4505258	EAMM-A-V20-28A
Third-party motor	28AA	8093016	EAMM-A-V20-28AA
EPCC-32			
With servo motor			
Third-party motor	38AA	8093162	EAMM-A-V25-38AA
EMME-AS-40-...	40P	4491059	EAMM-A-V25-40P
Third-party motor	40R	8087062	EAMM-A-V25-40R
Third-party motor	40RA	8094100	EAMM-A-V25-40RA
With stepper motor			
Third-party motor	35A, 35AB	8093255	EAMM-A-V25-35A
EMMS-ST-42-..., third-party motor	42A	4582608	EAMM-A-V25-42A
Third-party motor	42AB	8094108	EAMM-A-V25-42AB
EPCC-45			
With servo motor			
Third-party motor	38AA	8093023	EAMM-A-V32-38AA
EMME-AS-40-...	40P	4595742	EAMM-A-V32-40P
Third-party motor	40R	8087090	EAMM-A-V32-40R
Third-party motor	40RA	8094180	EAMM-A-V32-40RA
Third-party motor	58AA	8098982	EAMM-A-V32-58AA
EMMT-AS-60-..., EMME-AS-60-..., third-party motor	60P	4608750	EAMM-A-V32-60P
Third-party motor	60PA	8091053	EAMM-A-V32-60PA
Third-party motor	60RA	8093041	EAMM-A-V32-60RA
With stepper motor			
EMMS-ST-42-..., third-party motor	42A	4281142	EAMM-A-V32-42A
Third-party motor	42AB	8094200	EAMM-A-V32-42AB
EMMS-ST-57-...	57A	4597016	EAMM-A-V32-57A
Third-party motor	60AA	8092271	EAMM-A-V32-60AA
EPCC-60			
With servo motor			
EMMT-AS-60-..., EMME-AS-60-..., third-party motor	60P, 60PA	4133487	EAMM-A-T42-60P
Third-party motor	60R	8093289	EAMM-A-T42-60R
Third-party motor	60RA	8092264	EAMM-A-T42-60RA
EMME-AS-80-..., third-party motor	80P	4623788	EAMM-A-T42-80P
With stepper motor			
EMMS-ST-57-...	57A	4327034	EAMM-A-T42-57A
Third-party motor	60AA	8092255	EAMM-A-T42-60AA
Third-party motor	60AB	8094949	EAMM-A-T42-60AB
EMMS-ST-87-...	87A	4610008	EAMM-A-T42-87A

1) The input torque must not exceed the max. permissible transferable torque of the axial kit.

Product range overview

Permissible axis/motor combinations with electric cylinder ESBF

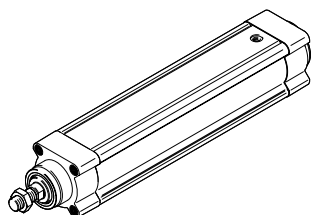

Table of interfaces for third-party motors

→ from page 58

Technical data for axial kits

→ from page 62

Motor/gear unit ¹⁾ Type	Motor interface	Axial kit	
		Part no.	Type
ESBF-32			
With servo motor			
EMME-AS-40-...	40P	★ 1976465	EAMM-A-D32-40P
		2207372	EAMM-A-D32-40P-S1 ²⁾
Third-party motor	40A	543147	EAMM-A-D32-40A
		1322178	EAMM-A-D32-40A-S1 ²⁾
Third-party motor	40R	8105826	EAMM-A-D32-40R
Third-party motor	40RA	8125610	EAMM-A-D32-40RA
Third-party motor	55A	550979	EAMM-A-D32-55A
		1322180	EAMM-A-D32-55A-S1 ²⁾
Third-party motor	58AA	8105884	EAMM-A-D32-58AA
EMMT-AS-60-..., EMME-AS-60-..., third-party motor	60P	★ 1956054	EAMM-A-D32-60P
		2234020	EAMM-A-D32-60P-S1 ²⁾
Third-party motor	60R	8105918	EAMM-A-D32-60R
Third-party motor	60RA	8105889	EAMM-A-D32-60RA
With servo motor and gear unit			
EMME-AS-40-...	40G	1454238	EAMM-A-D32-40G
EMGA-40-P-G-...-EAS-40		2256396	EAMM-A-D32-40G-S1 ²⁾
EMMT-AS-60-...	60H	2946760	EAMM-A-D32-60H
EMGA-60-P-G-...-EAS-60		2946761	EAMM-A-D32-60H-S1 ²⁾
EMME-AS-60-...	60H	2946760	EAMM-A-D32-60H
EMGA-60-P-G-...-EAS-60		2946761	EAMM-A-D32-60H-S1 ²⁾
With servo motor and angled gear unit			
EMME-AS-40-...	40G	1454238	EAMM-A-D32-40G
EMGA-40-A-G-...-40P		2256396	EAMM-A-D32-40G-S1 ²⁾
EMMT-AS-60-...	60H	2946760	EAMM-A-D32-60H
EMGA-60-A-G-...-60P		2946761	EAMM-A-D32-60H-S1 ²⁾
EMME-AS-60-...	60H	2946760	EAMM-A-D32-60H
EMGA-60-A-G-...-60P		2946761	EAMM-A-D32-60H-S1 ²⁾
With stepper motor			
Third-party motor	60AA	8105887	EAMM-A-D32-60AA

1) The input torque must not exceed the max. permissible transferable torque of the axial kit.

2) Increased degree of protection IP65

Festo core product range



Generally ready for shipping ex works in 24 hours

Generally ready for shipping ex works in 5 days

Product range overview

Permissible axis/motor combinations with electric cylinder ESBF

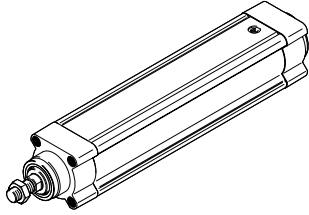

Table of interfaces for third-party motors

→ from page 58

Technical data for axial kits

→ from page 62

Motor/gear unit ¹⁾ Type	Motor interface	Axial kit	
		Part no.	Type
ESBF-32			
With stepper motor			
EMMS-ST-42-..., third-party motor	42A	★ 543148	EAMM-A-D32-42A
		1322179	EAMM-A-D32-42A-S1 ²⁾
EMMS-ST-57-...	57A	★ 550980	EAMM-A-D32-57A
		1322181	EAMM-A-D32-57A-S1 ²⁾
With stepper motor and gear unit			
EMMS-ST-42-... EMGA-40-P-G...SST-42	40G	1454238	EAMM-A-D32-40G
		2256396	EAMM-A-D32-40G-S1 ²⁾
EMMS-ST-57-... EMGA-60-P-G...SST-57	60G	2946758	EAMM-A-D32-60G
		2946759	EAMM-A-D32-60G-S1 ²⁾
With integrated drive			
EMCA-EC-67-...	67A	1454239	EAMM-A-D32-67A
		2256397	EAMM-A-D32-67A-S1 ²⁾
With integrated drive and gear unit			
EMCA-EC-67-... EMGC-40-...	40G	1454238	EAMM-A-D32-40G
		2256396	EAMM-A-D32-40G-S1 ²⁾
EMCA-EC-67-... EMGC-60-...	60H	2946760	EAMM-A-D32-60H
		2946761	EAMM-A-D32-60H-S1 ²⁾
With third-party gear unit			
Third-party gear unit	40G	1454238	EAMM-A-D32-40G
		2256396	EAMM-A-D32-40G-S1 ²⁾
Third-party gear unit	50GA	8117072	EAMM-A-D32-50GA
Third-party gear unit	60G	2946758	EAMM-A-D32-60G
		2946759	EAMM-A-D32-60G-S1 ²⁾
Third-party gear unit	60H	2946760	EAMM-A-D32-60H
		2946761	EAMM-A-D32-60H-S1 ²⁾

1) The input torque must not exceed the max. permissible transferable torque of the axial kit.

2) Increased degree of protection IP65



Product range overview

Permissible axis/motor combinations with electric cylinder ESBF

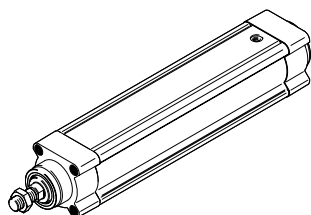

Table of interfaces for third-party motors

→ from page 58

Technical data for axial kits

→ from page 62

Motor/gear unit ¹⁾ Type	Motor interface	Axial kit	
		Part no.	Type
ESBF-40			
With servo motor			
Third-party motor	55A	543153	EAMM-A-D40-55A
		1322182	EAMM-A-D40-55A-S1 ²⁾
Third-party motor	58AA	8105928	EAMM-A-D40-58AA
EMMT-AS-60-..., EMME-AS-60-..., third-party motor	60P	★ 1977000	EAMM-A-D40-60P
		2151519	EAMM-A-D40-60P-S1 ²⁾
Third-party motor	60R	8117079	EAMM-A-D40-60R
Third-party motor	60RA	8117078	EAMM-A-D40-60RA
Third-party motor	70A	550981	EAMM-A-D40-70A
		1322185	EAMM-A-D40-70A-S1 ²⁾
Third-party motor	70AA, 70AB	8105952	EAMM-A-D40-70AA
With servo motor and gear unit			
EMME-AS-40-... EMGA-40-P-G...-EAS-40	40G	★ 560282	EAMM-A-D40-40G
		2256398	EAMM-A-D40-40G-G2 ³⁾
		2256399	EAMM-A-D40-40G-S1 ²⁾
EMMT-AS-60-... EMGA-60-P-G...-EAS-60	60H	1454242	EAMM-A-D40-60H
		2256401	EAMM-A-D40-60H-S1 ²⁾
EMME-AS-60-... EMGA-60-P-G...-EAS-60	60H	1454242	EAMM-A-D40-60H
		2256401	EAMM-A-D40-60H-S1 ²⁾
With servo motor and angled gear unit			
EMME-AS-40-... EMGA-40-A-G...-40P	40G	★ 560282	EAMM-A-D40-40G
		2256398	EAMM-A-D40-40G-G2 ³⁾
		2256399	EAMM-A-D40-40G-S1 ²⁾
EMMT-AS-60-... EMGA-60-A-G...-60P	60H	1454242	EAMM-A-D40-60H
		2256401	EAMM-A-D40-60H-S1 ²⁾
EMME-AS-60-... EMGA-60-A-G...-60P	60H	1454242	EAMM-A-D40-60H
		2256401	EAMM-A-D40-60H-S1 ²⁾
With stepper motor			
Third-party motor	60AA	8105929	EAMM-A-D40-60AA

1) The input torque must not exceed the max. permissible transferable torque of the axial kit.

2) Increased degree of protection IP65

3) The axial kit can be retrofitted from IP40 to IP65 with the help of a seal set EADS-F → page 105.

Festo core product range



Generally ready for shipping ex works in 24 hours

Generally ready for shipping ex works in 5 days

Product range overview

Permissible axis/motor combinations with electric cylinder ESBF

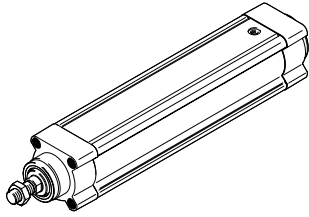

Table of interfaces for third-party motors

→ from page 58

Technical data for axial kits

→ from page 62

Motor/gear unit ¹⁾ Type	Motor interface	Axial kit	
		Part no.	Type
ESBF-40			
With stepper motor			
EMMS-ST-57-...	57A	★ 543154	EAMM-A-D40-57A
		1322183	EAMM-A-D40-57A-S1 ²⁾
EMMS-ST-87-...	87A	★ 550982	EAMM-A-D40-87A
		1322186	EAMM-A-D40-87A-S1 ²⁾
With stepper motor and gear unit			
EMMS-ST-42-... EMGA-40-P-G...-SST-42	40G	★ 560282	EAMM-A-D40-40G
		2256398	EAMM-A-D40-40G-G2 ³⁾
		2256399	EAMM-A-D40-40G-S1 ²⁾
EMMS-ST-57-... EMGA-60-P-G...-SST-57	60G	2256400	EAMM-A-D40-60G
		2256409	EAMM-A-D40-60G-S1 ²⁾
With integrated drive			
EMCA-EC-67-...	67A	1454243	EAMM-A-D40-67A
		2256695	EAMM-A-D40-67A-S1 ²⁾
With integrated drive and gear unit			
EMCA-EC-67-... EMGC-40-...	40G	★ 560282	EAMM-A-D40-40G
		2256398	EAMM-A-D40-40G-G2 ³⁾
		2256399	EAMM-A-D40-40G-S1 ²⁾
EMCA-EC-67-... EMGC-60-...	60H	1454242	EAMM-A-D40-60H
		2256401	EAMM-A-D40-60H-S1 ²⁾
With third-party gear unit			
Third-party gear unit	40G	★ 560282	EAMM-A-D40-40G
		2256398	EAMM-A-D40-40G-G2 ³⁾
		2256399	EAMM-A-D40-40G-S1 ²⁾
Third-party gear unit	50GA	8117076	EAMM-A-D40-50GA
Third-party gear unit	60G	2256400	EAMM-A-D40-60G
		2256409	EAMM-A-D40-60G-S1 ²⁾
Third-party gear unit	60H	1454242	EAMM-A-D40-60H
		2256401	EAMM-A-D40-60H-S1 ²⁾

1) The input torque must not exceed the max. permissible transferable torque of the axial kit.

2) Increased degree of protection IP65

3) The axial kit can be retrofitted from IP40 to IP65 with the help of a seal set EADS-F → page 105.

Festo core product range



Generally ready for shipping ex works in 24 hours

Generally ready for shipping ex works in 5 days

Product range overview

Permissible axis/motor combinations with electric cylinder ESBF

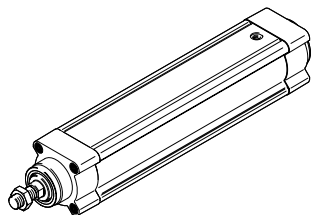

Table of interfaces for third-party motors

→ from page 58

Technical data for axial kits

→ from page 62

Motor/gear unit ¹⁾ Type	Motor interface	Axial kit	
		Part no.	Type
ESBF-50			
With servo motor			
Third-party motor	70A	2733783	EAMM-A-D50-70A
		2734287	EAMM-A-D50-70A-S1 ²⁾
EMME-AS-80-..., third-party motor	80P	★ 2733785	EAMM-A-D50-80P
		2734289	EAMM-A-D50-80P-S1 ²⁾
Third-party motor	80PB, 80R	8123493	EAMM-A-D50-80PB
Third-party motor	82AA	8123491	EAMM-A-D50-82AA
Third-party motor	84AA	8123490	EAMM-A-D50-84AA
EMME-AS-100-..., third-party motor	100A	★ 2733784	EAMM-A-D50-100A
		2734288	EAMM-A-D50-100A-S1 ²⁾
Third-party motor	100A	★ 2733784	EAMM-A-D50-100A
		2734288	EAMM-A-D50-100A-S1 ²⁾
With servo motor and gear unit			
EMMT-AS-60-... EMGA-60-P-G...-EAS-60	60H	2733796	EAMM-A-D50-60H
		2907418	EAMM-A-D50-60H-S1 ²⁾
EMME-AS-60-... EMGA-60-P-G...-EAS-60	60H	2733796	EAMM-A-D50-60H
		2907418	EAMM-A-D50-60H-S1 ²⁾
EMME-AS-80-... EMGA-80-P-G...-EAS-80	80G	2733787	EAMM-A-D50-80G
		2734291	EAMM-A-D50-80G-S1 ²⁾
EMME-AS-100-... EMGA-80-P-G...-SAS-100	80G	2733787	EAMM-A-D50-80G
		2734291	EAMM-A-D50-80G-S1 ²⁾
With servo motor and angled gear unit			
EMMT-AS-60-... EMGA-60-A-G...-60P	60H	2733796	EAMM-A-D50-60H
		2907418	EAMM-A-D50-60H-S1 ²⁾
EMME-AS-60-... EMGA-60-A-G...-60P	60H	2733796	EAMM-A-D50-60H
		2907418	EAMM-A-D50-60H-S1 ²⁾
EMME-AS-80-... EMGA-80-A-G...-80P	80G	2733787	EAMM-A-D50-80G
		2734291	EAMM-A-D50-80G-S1 ²⁾
EMME-AS-100-... EMGA-80-A-G...-100A	80G	2733787	EAMM-A-D50-80G
		2734291	EAMM-A-D50-80G-S1 ²⁾
With third-party gear unit			
Third-party gear unit	70GA	8123492	EAMM-A-D50-70GA

1) The input torque must not exceed the max. permissible transferable torque of the axial kit.

2) Increased degree of protection IP65

Festo core product range



Generally ready for shipping ex works in 24 hours

Generally ready for shipping ex works in 5 days

Product range overview

Permissible axis/motor combinations with electric cylinder ESBF

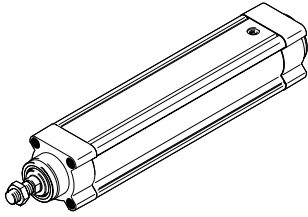

Table of interfaces for third-party motors

→ from page 58

Technical data for axial kits

→ from page 62

Motor/gear unit ¹⁾ Type	Motor interface	Axial kit	
		Part no.	Type
ESBF-50			
With stepper motor			
EMMS-ST-87-...	87A	★ 2733781	EAMM-A-D50-87A
		2734286	EAMM-A-D50-87A-S1 ²⁾
With stepper motor and gear unit			
EMMS-ST-57-... EMGA-60-P-G...-SST-57	60G	2733786	EAMM-A-D50-60G
		2734290	EAMM-A-D50-60G-S1 ²⁾
EMMS-ST-87-... EMGA-80-P-G...-SST-87	80G	2733787	EAMM-A-D50-80G
		2734291	EAMM-A-D50-80G-S1 ²⁾
With integrated drive and gear unit			
EMCA-EC-67-... EMGC-60-...	60H	2733796	EAMM-A-D50-60H
		2907418	EAMM-A-D50-60H-S1 ²⁾
With third-party gear unit			
Third-party gear unit	60G	2733786	EAMM-A-D50-60G
		2734290	EAMM-A-D50-60G-S1 ²⁾
Third-party gear unit	60H	2733796	EAMM-A-D50-60H
		2907418	EAMM-A-D50-60H-S1 ²⁾
Third-party gear unit	80G	2733787	EAMM-A-D50-80G
		2734291	EAMM-A-D50-80G-S1 ²⁾

1) The input torque must not exceed the max. permissible transferable torque of the axial kit.

2) Increased degree of protection IP65

Festo core product range



Generally ready for shipping ex works in 24 hours

Generally ready for shipping ex works in 5 days

Product range overview

Permissible axis/motor combinations with electric cylinder ESBF

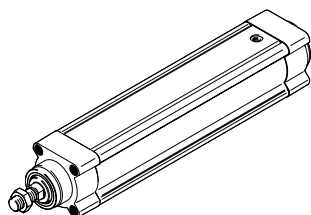

Table of interfaces for third-party motors

→ from page 58

Technical data for axial kits

→ from page 62

Motor/gear unit ¹⁾ Type	Motor interface	Axial kit	
		Part no.	Type
ESBF-63			
With servo motor			
Third-party motor	70A	543161 2256699	EAMM-A-D60-70A EAMM-A-D60-70A-S1 ²⁾
EMME-AS-80-..., third-party motor	80P	★ 1977073 2218564	EAMM-A-D60-80P EAMM-A-D60-80P-S1 ²⁾
Third-party motor	80PB, 80R	8105937	EAMM-A-D60-80PB
Third-party motor	84AA	8105945	EAMM-A-D60-84AA
EMME-AS-100-..., third-party motor	100A	★ 550983 2256700	EAMM-A-D60-100A EAMM-A-D60-100A-S1 ²⁾
Third-party motor	100A	★ 550983 2256700	EAMM-A-D60-100A EAMM-A-D60-100A-S1 ²⁾
With servo motor and gear unit			
EMMT-AS-60-... EMGA-60-P-G...-EAS-60	60H	1454245 2256697	EAMM-A-D60-60H EAMM-A-D60-60H-S1 ²⁾
EMME-AS-60-... EMGA-60-P-G...-EAS-60	60H	1454245 2256697	EAMM-A-D60-60H EAMM-A-D60-60H-S1 ²⁾
EMME-AS-80-... EMGA-80-P-G...-EAS-80	80G	1499402 2946762	EAMM-A-D60-80G EAMM-A-D60-80G-S1 ²⁾
EMME-AS-100-... EMGA-80-P-G...-SAS-100	80G	1499402 2946762	EAMM-A-D60-80G EAMM-A-D60-80G-S1 ²⁾
With servo motor and angled gear unit			
EMMT-AS-60-... EMGA-60-A-G...-60P	60H	1454245 2256697	EAMM-A-D60-60H EAMM-A-D60-60H-S1 ²⁾
EMME-AS-60-... EMGA-60-A-G...-60P	60H	1454245 2256697	EAMM-A-D60-60H EAMM-A-D60-60H-S1 ²⁾
EMME-AS-80-... EMGA-80-A-G...-80P	80G	1499402 2946762	EAMM-A-D60-80G EAMM-A-D60-80G-S1 ²⁾
EMME-AS-100-... EMGA-80-A-G...-100A	80G	1499402 2946762	EAMM-A-D60-80G EAMM-A-D60-80G-S1 ²⁾
With third-party gear unit			
Third-party gear unit	90GA	8105944	EAMM-A-D60-90GA

- 1) The input torque must not exceed the max. permissible transferable torque of the axial kit.
 2) Increased degree of protection IP65
 3) The axial kit can be retrofitted from IP40 to IP65 with the help of a seal set EADS-F → page 105.

Festo core product range



Generally ready for shipping ex works in 24 hours

Generally ready for shipping ex works in 5 days

Product range overview

Permissible axis/motor combinations with electric cylinder ESBF

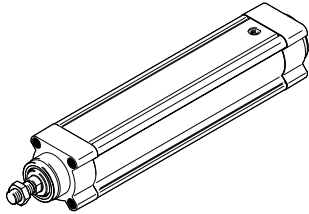

Table of interfaces for third-party motors

→ from page 58

Technical data for axial kits

→ from page 62

Motor/gear unit ¹⁾ Type	Motor interface	Axial kit	
		Part no.	Type
ESBF-63			
With stepper motor			
EMMS-ST-87-...	87A	★ 543162	EAMM-A-D60-87A
		1322188	EAMM-A-D60-87A-S1 ²⁾
With stepper motor and gear unit			
EMMS-ST-57-... EMGA-60-P-G...-SST-57	60G	★ 560283	EAMM-A-D60-60G
		2256696	EAMM-A-D60-60G-G2 ³⁾
		2256698	EAMM-A-D60-60G-S1 ²⁾
EMMS-ST-87-... EMGA-80-P-G...-SST-87	80G	1499402	EAMM-A-D60-80G
		2946762	EAMM-A-D60-80G-S1 ²⁾
With integrated drive and gear unit			
EMCA-EC-67-... EMGC-60-...	80H	1454245	EAMM-A-D60-80H
		2256697	EAMM-A-D60-80H-S1 ²⁾
With third-party gear unit			
Third-party gear unit	60G	★ 560283	EAMM-A-D60-60G
		2256696	EAMM-A-D60-60G-G2 ³⁾
		2256698	EAMM-A-D60-60G-S1 ²⁾
Third-party gear unit	60H	1454245	EAMM-A-D60-60H
		2256697	EAMM-A-D60-60H-S1 ²⁾
Third-party gear unit	80G	1499402	EAMM-A-D60-80G
		2946762	EAMM-A-D60-80G-S1 ²⁾
ESBF-80			
With servo motor			
Third-party motor	84AA	8110055	EAMM-A-D80-84AA
EMME-AS-100-..., third-party motor	100A	1589665	EAMM-A-D80-100A
		1600673	EAMM-A-D80-100A-S1 ²⁾
EMMS-AS-140-...	140A	1588299	EAMM-A-D80-140A
		1600674	EAMM-A-D80-140A-S1 ²⁾

- 1) The input torque must not exceed the max. permissible transferable torque of the axial kit.
- 2) Increased degree of protection IP65
- 3) The axial kit can be retrofitted from IP40 to IP65 with the help of a seal set EADS-F → page 1.

Festo core product range



Generally ready for shipping ex works in 24 hours

Generally ready for shipping ex works in 5 days

Product range overview

Permissible axis/motor combinations with electric cylinder ESBF

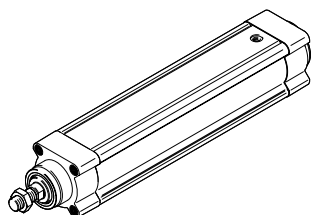

Table of interfaces for third-party motors

→ from page 58

Technical data for axial kits

→ from page 62

Motor/gear unit ¹⁾ Type	Motor interface	Axial kit	
		Part no.	Type
ESBF-80			
With servo motor and gear unit			
EMME-AS-80-... EMGA-80-P-G...-EAS-80	80G	2946763 2946764	EAMM-A-D80-80G EAMM-A-D80-80G-S1 ²⁾
EMME-AS-100-... EMGA-80-P-G...-SAS-100	80G	2946763 2946764	EAMM-A-D80-80G EAMM-A-D80-80G-S1 ²⁾
With servo motor and angled gear unit			
EMME-AS-80-... EMGA-80-A-G...-80P	80G	2946763 2946764	EAMM-A-D80-80G EAMM-A-D80-80G-S1 ²⁾
EMME-AS-100-... EMGA-80-A-G...-100A	80G	2946763 2946764	EAMM-A-D80-80G EAMM-A-D80-80G-S1 ²⁾
With stepper motor and gear unit			
EMMS-ST-87-... EMGA-80-P-G...-SST-87	80G	2946763 2946764	EAMM-A-D80-80G EAMM-A-D80-80G-S1 ²⁾
With third-party gear unit			
Third-party gear unit	80G	2946763 2946764	EAMM-A-D80-80G EAMM-A-D80-80G-S1 ²⁾
Third-party gear unit	90GA	8110063	EAMM-A-D80-90GA
ESBF-100			
With servo motor			
EMME-AS-100-..., third-party motor	100A	3356796 3356931	EAMM-A-D100-100A EAMM-A-D100-100A-S1 ²⁾
EMMS-AS-140-...	140A	1588349 1600675	EAMM-A-D100-140A EAMM-A-D100-140A-S1 ²⁾
With servo motor and gear unit			
EMME-AS-100-... EMGA-120-P-G...-SAS-100	120G	2449341 2946765	EAMM-A-D100-120G EAMM-A-D100-120G-S1 ²⁾
EMMS-AS-140-... EMGA-120-P-G...-SAS-140	120G	2449341 2946765	EAMM-A-D100-120G EAMM-A-D100-120G-S1 ²⁾
With third-party gear unit			
Third-party gear unit	120G	2449341 2946765	EAMM-A-D100-120G EAMM-A-D100-120G-S1 ²⁾

1) The input torque must not exceed the max. permissible transferable torque of the axial kit.

2) Increased degree of protection IP65

Product range overview

Permissible axis/motor combinations with toothed belt axis EGC-TB

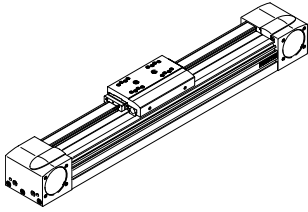

Table of interfaces for third-party motors

→ from page 58

Technical data for axial kits

→ from page 62

Motor/gear unit ¹⁾ Type	Interface Motor	Axial kit	
		Part no.	Type
EGC-50-...-TB			
With servo motor			
Third-party motor	40A	8063444	EAMM-A-L27-40A
Third-party motor	40R	8063445	EAMM-A-L27-40R
Third-party motor	40RA	8063446	EAMM-A-L27-40RA
Third-party motor	55A	557975	EAMM-A-L27-55A
Third-party motor	58AA	8063448	EAMM-A-L27-58AA
Third-party motor	60RA	8063452	EAMM-A-L27-60RA
Third-party motor	60RB	8063453	EAMM-A-L27-60RB
With servo motor and gear unit			
EMME-AS-40-... EMGA-40-P-G-...-EAS-40	40G	★ 557974	EAMM-A-L27-40G
With servo motor and angled gear unit			
EMME-AS-40-... EMGA-40-A-G-...-40P	40G	★ 557974	EAMM-A-L27-40G
With stepper motor			
EMMS-ST-42-..., third-party motor	42A	8063447	EAMM-A-L27-42A
EMMS-ST-57-...	57A	★ 560678	EAMM-A-L27-57A
Third-party motor	57AA	8063449	EAMM-A-L27-57AA
Third-party motor	57AB	8063450	EAMM-A-L27-57AB
Third-party motor	57AC	8063451	EAMM-A-L27-57AC
With stepper motor and gear unit			
EMMS-ST-42-... EMGA-40-P-G-...-SST-42	40G	★ 557974	EAMM-A-L27-40G
With integrated drive			
EMCA-EC-67-...	67A	1454261	EAMM-A-L27-67A
With integrated drive and gear unit			
EMCA-EC-67-... EMGC-40	40G	★ 557974	EAMM-A-L27-40G
With third-party gear unit			
Third-party gear unit	50GA	8063454	EAMM-A-L27-50GA
Third-party gear unit	60G	8063455	EAMM-A-L27-60G

1) The input torque must not exceed the max. permissible transferable torque of the axial kit.



Product range overview

Permissible axis/motor combinations with toothed belt axis EGC-TB

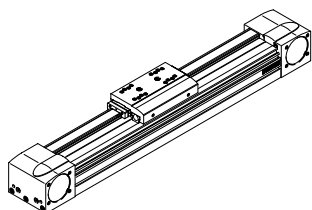

Table of interfaces for third-party motors

→ from page 58

Technical data for axial kits

→ from page 62

Motor/gear unit ¹⁾ Type	Motor interface	Axial kit	
		Part no.	Type
EGC-70-...-TB			
With servo motor			
Third-party motor	55A	3683331	EAMM-A-L38-55A
Third-party motor	58AA	8063456	EAMM-A-L38-58AA
EMMT-AS-60-..., EMME-AS-60-..., third-party motor	60P	★ 2037246	EAMM-A-L38-60P
Third-party motor	60PA	8063459	EAMM-A-L38-60PA
Third-party motor	60R	8107703	EAMM-A-L38-60R
Third-party motor	60RB	8063460	EAMM-A-L38-60RB
Third-party motor	70A	557979	EAMM-A-L38-70A
Third-party motor	70AA, 70AB	8063461	EAMM-A-L38-70AA
Third-party motor	88A	8063463	EAMM-A-L38-88A
Third-party motor	84AA	8063464	EAMM-A-L38-84AA
With servo motor and gear unit			
EMMT-AS-60-... EMGA-60-P-G-...-EAS-60	60H	1456610	EAMM-A-L38-60H
EMME-AS-60-... EMGA-60-P-G-...-EAS-60	60H	1456610	EAMM-A-L38-60H
With servo motor and angled gear unit			
EMMT-AS-60-... EMGA-60-A-G-...-60P	60H	1456610	EAMM-A-L38-60H
EMME-AS-60-... EMGA-60-A-G-...-60P	60H	1456610	EAMM-A-L38-60H
With stepper motor			
EMMS-ST-57-... Third-party motor	57A	★ 560679	EAMM-A-L38-57A
Third-party motor	57AA	8063457	EAMM-A-L38-57AA
Third-party motor	60AA	8107702	EAMM-A-L38-60AA
EMMS-ST-87-... Third-party motor	87A	★ 560680	EAMM-A-L38-87A
With stepper motor and gear unit			
EMMS-ST-57-... EMGA-60-P-G-...-SST-57	60G	★ 557978	EAMM-A-L38-60G
With integrated drive and gear unit			
EMCA-EC-67-... EMGC-60-... Third-party gear unit	60H	1456610	EAMM-A-L38-60H
Third-party gear unit	40G	8063465	EAMM-A-L38-40G
Third-party gear unit	50GA	8063466	EAMM-A-L38-50GA
Third-party gear unit	56GA	8063467	EAMM-A-L38-56GA
Third-party gear unit	70GA	8063468	EAMM-A-L38-70GA
Third-party gear unit	68GA	8063469	EAMM-A-L38-68GA
Third-party gear unit	72GA	8063470	EAMM-A-L38-72GA

1) The input torque must not exceed the max. permissible transferable torque of the axial kit.

Festo core product range



Generally ready for shipping ex works in 24 hours

Generally ready for shipping ex works in 5 days

Product range overview

Permissible axis/motor combinations with toothed belt axis EGC-TB

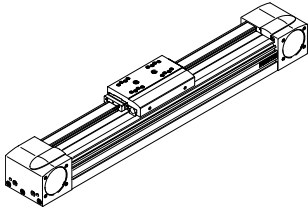

Table of interfaces for third-party motors

→ from page 58

Technical data for axial kits

→ from page 62

Motor/gear unit ¹⁾ Type	Motor interface	Axial kit	
		Part no.	Type
EGC-80-...-TB			
With servo motor			
Third-party motor	55A	8063471	EAMM-A-L48-55A
Third-party motor	60PA	8063472	EAMM-A-L48-60PA
Third-party motor	70A	557982	EAMM-A-L48-70A
Third-party motor	70AA, 70AB	8063473	EAMM-A-L48-70AA
EMME-AS-80-..., third-party motor	80P	★ 2042616	EAMM-A-L48-80P
Third-party motor	80PB	8123168	EAMM-A-L48-80PB
Third-party motor	82AA	8063475	EAMM-A-L48-82AA
Third-party motor	84AA	8063479	EAMM-A-L48-84AA
Third-party motor	88A	8063476	EAMM-A-L48-88A
Third-party motor	90R	8063477	EAMM-A-L48-90R
Third-party motor	92RA	8063478	EAMM-A-L48-92RA
EMME-AS-100-..., third-party motor	100A	557984	EAMM-A-L48-100A
With servo motor and gear unit			
EMMT-AS-60-... EMGA-60-P-G...-EAS-60	60H	1456611	EAMM-A-L48-60H
EMME-AS-60-... EMGA-60-P-G...-EAS-60	60H	1456611	EAMM-A-L48-60H
With servo motor and angled gear unit			
EMMT-AS-60-... EMGA-60-A-G...-60P	60H	1456611	EAMM-A-L48-60H
EMME-AS-60-... EMGA-60-A-G...-60P	60H	1456611	EAMM-A-L48-60H

1) The input torque must not exceed the max. permissible transferable torque of the axial kit.



Product range overview

Permissible axis/motor combinations with toothed belt axis EGC-TB

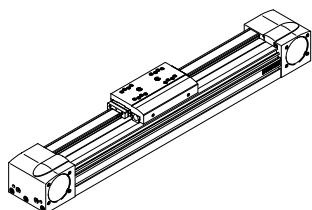

Table of interfaces for third-party motors

→ from page 58

Technical data for axial kits

→ from page 62

Motor/gear unit ¹⁾ Type	Motor interface	Axial kit	
		Part no.	Type
With stepper motor			
EMMS-ST-87-...	87A	★ 560683	EAMM-A-L48-87A
With stepper motor and gear unit			
EMMS-ST-57-... EMGA-60-P-G...-SST-57	60G	★ 557983	EAMM-A-L48-60G
With integrated drive and gear unit			
EMCA-EC-67-... EMGC-60-...	60H	1456611	EAMM-A-L48-60H
With third-party gear unit			
Third-party gear unit	40G	8063480	EAMM-A-L48-40G
Third-party gear unit	50GA	8063481	EAMM-A-L48-50GA
Third-party gear unit	56GA	8063482	EAMM-A-L48-56GA
Third-party gear unit	70GA	8063483	EAMM-A-L48-70GA
Third-party gear unit	75GA	8063484	EAMM-A-L48-75GA
Third-party gear unit	80G	8063485	EAMM-A-L48-80G
Third-party gear unit	68GA	8063486	EAMM-A-L48-68GA
Third-party gear unit	72GA	8063487	EAMM-A-L48-72GA
Third-party gear unit	90GA	8063489	EAMM-A-L48-90GA
Third-party gear unit	120GA	8063490	EAMM-A-L48-120GA

1) The input torque must not exceed the max. permissible transferable torque of the axial kit.

Festo core product range



Generally ready for shipping ex works in 24 hours

Generally ready for shipping ex works in 5 days

Product range overview

Permissible axis/motor combinations with toothed belt axis EGC-TB

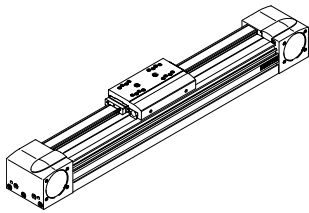

Table of interfaces for third-party motors

→ from page 58

Technical data for axial kits

→ from page 62

Motor/gear unit ¹⁾ Type	Motor interface	Axial kit	
		Part no.	Type
EGC-120-...-TB			
With servo motor			
Third-party motor	88A	8063492	EAMM-A-L62-88A
Third-party motor	84AA	8063493	EAMM-A-L62-84AA
Third-party motor	108AA	8063494	EAMM-A-L62-108AA
EMME-AS-100-..., third-party motor	100A	★ 557988	EAMM-A-L62-100A
EMMS-AS-140-...	140A	557990	EAMM-A-L62-140A
With servo motor and gear unit			
Third-party gear unit	60H	8063498	EAMM-A-L62-60H
EMME-AS-80-... EMGA-80-P-G...-EAS-80	80G	★ 557989	EAMM-A-L62-80G
EMME-AS-100-... EMGA-80-P-G...-SAS-100	80G	★ 557989	EAMM-A-L62-80G
With servo motor and angled gear unit			
EMME-AS-80-... EMGA-80-A-G...-80P	80G	★ 557989	EAMM-A-L62-80G
EMME-AS-100-... EMGA-80-A-G...-100A	80G	★ 557989	EAMM-A-L62-80G
With stepper motor and gear unit			
EMMS-ST-87-... EMGA-80-P-G...-SST-87	80G	★ 557989	EAMM-A-L62-80G
With third-party gear unit			
Third-party gear unit	56GA	8063497	EAMM-A-L62-56GA
Third-party gear unit	70GA	8063499	EAMM-A-L62-70GA
Third-party gear unit	75GA	8063500	EAMM-A-L62-75GA
Third-party gear unit	86GA	8063502	EAMM-A-L62-86GA
Third-party gear unit	72GA	8063503	EAMM-A-L62-72GA
Third-party gear unit	90GA	8063505	EAMM-A-L62-90GA
Third-party gear unit	115GA	8063506	EAMM-A-L62-115GA
Third-party gear unit	120G	8063507	EAMM-A-L62-120G
Third-party gear unit	120GA	8063508	EAMM-A-L62-120GA
Third-party gear unit	120GB	8063509	EAMM-A-L62-120GB
Third-party gear unit	120GC	8063510	EAMM-A-L62-120GC

1) The input torque must not exceed the max. permissible transferable torque of the axial kit.

Festo core product range



Generally ready for shipping ex works in 24 hours

Generally ready for shipping ex works in 5 days

Product range overview

Permissible axis/motor combinations with toothed belt axis EGC-TB

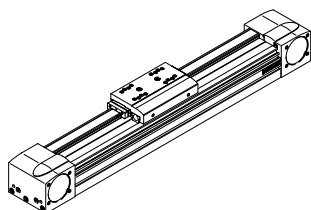

Table of interfaces for third-party motors

→ from page 58

Technical data for axial kits

→ from page 62

Motor/gear unit ¹⁾ Type	Motor interface	Axial kit	
		Part no.	Type
EGC-185-...-TB			
With servo motor			
EMMS-AS-140-...	140A	3657226	EAMM-A-L95-140A-G2
EMMS-AS-190-...	190A	3659562	EAMM-A-L95-190A-G2
With servo motor and gear unit			
EMME-AS-80-... EMGA-80-P-G-...-EAS-80	80G	3660191	EAMM-A-L95-80G-G2
EMME-AS-100-... EMGA-80-P-G-...-SAS-100	80G	3660191	EAMM-A-L95-80G-G2
EMME-AS-100-... EMGA-120-P-G-...-SAS-100	120G	★ 3659941	EAMM-A-L95-120G-G2
EMMS-AS-140-... EMGA-120-P-G-...-SAS-140	120G	★ 3659941	EAMM-A-L95-120G-G2
With servo motor and angled gear unit			
EMME-AS-80-... EMGA-80-A-G-...-80P	80G	3660191	EAMM-A-L95-80G-G2
EMME-AS-100-... EMGA-80-A-G-...-100A	80G	3660191	EAMM-A-L95-80G-G2
With third-party gear unit			
Third-party gear unit	75GA	8063522	EAMM-A-L95-75GA
Third-party gear unit	68GA	8063524	EAMM-A-L95-68GA
Third-party gear unit	72GA	8063525	EAMM-A-L95-72GA
Third-party gear unit	90GA	8063526	EAMM-A-L95-90GA
Third-party gear unit	115GA	8063527	EAMM-A-L95-115GA
Third-party gear unit	120GA	8063529	EAMM-A-L95-120GA
Third-party gear unit	120GB	8063530	EAMM-A-L95-120GB
Third-party gear unit	120GC	8063531	EAMM-A-L95-120GC
Third-party gear unit	160G	8063532	EAMM-A-L95-160G

1) The input torque must not exceed the max. permissible transferable torque of the axial kit.

Festo core product range



Generally ready for shipping ex works in 24 hours

Generally ready for shipping ex works in 5 days

Product range overview

Permissible axis/motor combinations with spindle axis EGC-BS

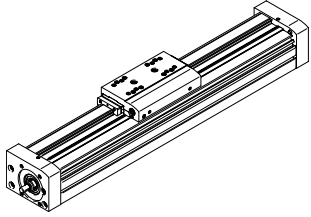

Table of interfaces for third-party motors

→ from page 58

Technical data for axial kits

→ from page 62

Motor/gear unit ¹⁾ Type	Motor interface	Axial kit	
		Part no.	Type
EGC-70-...-BS			
With servo motor			
EMME-AS-40-...	40P	★ 3637972	EAMM-A-S38-40P-G2
Third-party motor	40A	3637971	EAMM-A-S38-40A-G2
Third-party motor	55A	3637967	EAMM-A-S38-55A-G2
Third-party motor	58AA	8105927	EAMM-A-S38-58AA
EMMT-AS-60-..., EMME-AS-60-..., third-party motor	60P	★ 3637958	EAMM-A-S38-60P-G2
Third-party motor	60R	8105923	EAMM-A-S38-60R
Third-party motor	60RA	8105924	EAMM-A-S38-60RA
With servo motor and gear unit			
EMME-AS-40-... EMGA-40-P-G...-EAS-40	40G	1456647	EAMM-A-S38-40G-G2
With servo motor and angled gear unit			
EMME-AS-40-... EMGA-40-A-G...-40P	40G	1456647	EAMM-A-S38-40G-G2
With stepper motor			
EMMS-ST-42-..., third-party motor	42A	★ 3637965	EAMM-A-S38-42A-G2
EMMS-ST-57-...	57A	★ 3637956	EAMM-A-S38-57A-G2
Third-party motor	60AA	8105926	EAMM-A-S38-60AA
With stepper motor and gear unit			
EMMS-ST-42-... EMGA-40-P-G...-SST-42	40G	1456647	EAMM-A-S38-40G-G2
With integrated drive			
EMCA-EC-67-...	67A	1456638	EAMM-A-S38-67A-G2
With integrated drive and gear unit			
EMCA-EC-67-... EMGC-40-...	40G	1456647	EAMM-A-S38-40G-G2
With third-party gear unit			
Third-party gear unit	50GA	8105922	EAMM-A-S38-50GA

1) The input torque must not exceed the max. permissible transferable torque of the axial kit.



Product range overview

Permissible axis/motor combinations with spindle axis EGC-BS

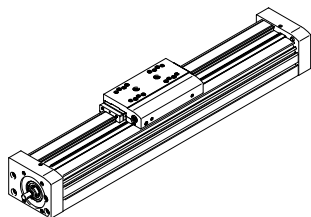

Table of interfaces for third-party motors

→ from page 58

Technical data for axial kits

→ from page 62

Motor/gear unit ¹⁾ Type	Motor interface	Axial kit	
		Part no.	Type
EGC-80-...-BS			
With servo motor			
Third-party motor	55A	3637961	EAMM-A-S48-55A-G2
Third-party motor	58AA	8105933	EAMM-A-S48-58AA
EMMT-AS-60-..., EMME-AS-60-..., third-party motor	60P	★ 3637964	EAMM-A-S48-60P-G2
Third-party motor	60R	8105939	EAMM-A-S48-60R
Third-party motor	60RA	8105941	EAMM-A-S48-60RA
Third-party motor	70A	3637957	EAMM-A-S48-70A-G2
Third-party motor	70AA, 70AB	8105942	EAMM-A-S48-70AA
With servo motor and gear unit			
EMME-AS-40-... EMGA-40-P-G...-EAS-40	40G	1456650	EAMM-A-S48-40G-G2
EMMT-AS-60-... EMGA-60-P-G...-EAS-60	60H	1456652	EAMM-A-S48-60H-G2
EMME-AS-60-... EMGA-60-P-G...-EAS-60	60H	1456652	EAMM-A-S48-60H-G2
With servo motor and angled gear unit			
EMME-AS-40-... EMGA-40-A-G...-40P	40G	1456650	EAMM-A-S48-40G-G2
EMMT-AS-60-... EMGA-60-A-G...-60P	60H	1456652	EAMM-A-S48-60H-G2
EMME-AS-60-... EMGA-60-A-G...-60P	60H	1456652	EAMM-A-S48-60H-G2
With stepper motor			
EMMS-ST-57-...	57A	★ 3637963	EAMM-A-S48-57A-G2
Third-party motor	60AA	8105935	EAMM-A-S48-60AA
EMMS-ST-87-...	87A	★ 3637962	EAMM-A-S48-87A-G2
With stepper motor and gear unit			
EMMS-ST-42-... EMGA-40-P-G...-SST-42	40G	1456650	EAMM-A-S48-40G-G2
EMMS-ST-57-... EMGA-60-P-G...-SST-57	60G	2256701	EAMM-A-S48-60G-G2
With integrated drive and gear unit			
EMCA-EC-67-... EMGC-40	40G	1456650	EAMM-A-S48-40G-G2
EMCA-EC-67-... EMGC-60-...	60H	1456652	EAMM-A-S48-60H-G2
With third-party gear unit			
Third-party gear unit	50GA	8105930	EAMM-A-S48-50GA

1) The input torque must not exceed the max. permissible transferable torque of the axial kit.

Festo core product range



Generally ready for shipping ex works in 24 hours

Generally ready for shipping ex works in 5 days

Product range overview

Permissible axis/motor combinations with spindle axis EGC-BS

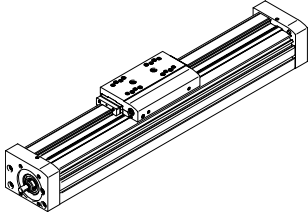

Table of interfaces for third-party motors

→ from page 58

Technical data for axial kits

→ from page 62

Motor/gear unit ¹⁾ Type	Motor interface	Axial kit	
		Part no.	Type
EGC-120-...-BS			
With servo motor			
Third-party motor	70A	3637959	EAMM-A-S62-70A-G2
EMME-AS-80-..., third-party motor	80P	★ 3637970	EAMM-A-S62-80P-G2
Third-party motor	80PB, 80R	8110208	EAMM-A-S62-80PB
Third-party motor	82AA	8110211	EAMM-A-S62-82AA
Third-party motor	84AA	8110226	EAMM-A-S62-84AA
EMME-AS-100-..., third-party motor	100A	★ 3637960	EAMM-A-S62-100A-G2
EMMS-AS-140-...	140A	3637969	EAMM-A-S62-140A-G2
With servo motor and gear unit			
EMMT-AS-60-... EMGA-60-P-G...-EAS-60	60H	1456654	EAMM-A-S62-60H-G2
EMME-AS-60-... EMGA-60-P-G...-EAS-60	60H	1456654	EAMM-A-S62-60H-G2
EMME-AS-80-... EMGA-80-P-G...-EAS-80	80G	1972530	EAMM-A-S62-80G-G2
EMME-AS-100-... EMGA-80-P-G...-SAS-100	80G	1972530	EAMM-A-S62-80G-G2
With servo motor and angled gear unit			
EMMT-AS-60-... EMGA-60-A-G...-60P	60H	1456654	EAMM-A-S62-60H-G2
EMME-AS-60-... EMGA-60-A-G...-60P	60H	1456654	EAMM-A-S62-60H-G2
EMME-AS-80-... EMGA-80-A-G...-80P	80G	1972530	EAMM-A-S62-80G-G2
EMME-AS-100-... EMGA-80-A-G...-100A	80G	1972530	EAMM-A-S62-80G-G2

1) The input torque must not exceed the max. permissible transferable torque of the axial kit.



Product range overview

Permissible axis/motor combinations with spindle axis EGC-BS

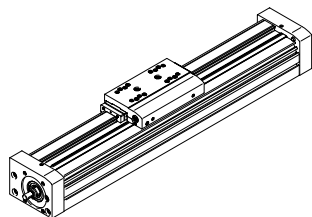

Table of interfaces for third-party motors

→ from page 58

Technical data for axial kits

→ from page 62

Motor/gear unit ¹⁾ Type	Motor interface	Axial kit	
		Part no.	Type
EGC-120-...-BS			
With stepper motor			
EMMS-ST-87-...	87A	★ 3637966	EAMM-A-S62-87A-G2
With stepper motor and gear unit			
EMMS-ST-57-... EMGA-60-P-G...-SST-57	60G	2297649	EAMM-A-S62-60G-G2
EMMS-ST-87-... EMGA-80-P-G...-SST-87	80G	1972530	EAMM-A-S62-80G-G2
With integrated drive and gear unit			
EMCA-EC-67-... EMGC-60-...	60H	1456654	EAMM-A-S62-60H-G2
With third-party gear unit			
Third-party gear unit	70GA	8110082	EAMM-A-S62-70GA
EGC-185-...-BS			
With servo motor			
Third-party motor	84AA	8107720	EAMM-A-S95-84AA
EMME-AS-100-..., third-party motor	100A	3637955	EAMM-A-S95-100A-G2
EMMS-AS-140-...	140A	3637954	EAMM-A-S95-140A-G2
With third-party gear unit			
Third-party gear unit	90GA	8110066	EAMM-A-S95-90GA

1) The input torque must not exceed the max. permissible transferable torque of the axial kit.

Festo core product range



Generally ready for shipping ex works in 24 hours

Generally ready for shipping ex works in 5 days

Product range overview

Permissible axis/motor combinations with toothed belt axis ELGA-TB-...

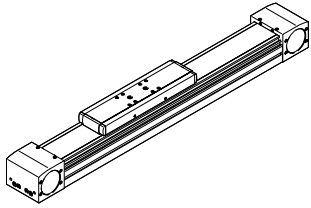

Table of interfaces for third-party motors

→ from page 58

Technical data for axial kits

→ from page 62

Motor/gear unit ¹⁾ Type	Motor interface	Axial kit	
		Part no.	Type
ELGA-TB-...-70			
With servo motor			
Third-party motor	60PA	8063574	EAMM-A-N38-60PA
Third-party gear unit	60RA	8063575	EAMM-A-N38-60RA
Third-party motor	70A	1202331	EAMM-A-N38-70A
Third-party motor	70AA, 70AB	8063576	EAMM-A-N38-70AA
Third-party motor	88A	8063579	EAMM-A-N38-88A
Third-party motor	90R	8063580	EAMM-A-N38-90R
Third-party motor	92RA	8063581	EAMM-A-N38-92RA
With servo motor and gear unit			
EMMT-AS-60-... EMGA-60-P-G...-EAS-60	60H	1456616	EAMM-A-N38-60H
EMME-AS-60-... EMGA-60-P-G...-EAS-60	60H	1456616	EAMM-A-N38-60H
With servo motor and angled gear unit			
EMMT-AS-60-... EMGA-60-A-G...-60P	60H	1456616	EAMM-A-N38-60H
EMME-AS-60-... EMGA-60-A-G...-60P	60H	1456616	EAMM-A-N38-60H
With stepper motor			
EMMS-ST-87-...	87A	★ 3324111	EAMM-A-N38-87A
With stepper motor and gear unit			
EMMS-ST-57-... EMGA-60-P-G...-SST-57	60G	★ 1202253	EAMM-A-N38-60G
With integrated drive and gear unit			
EMCA-EC-67-... EMGC-60-...	60H	1456616	EAMM-A-N38-60H
With third-party gear unit			
Third-party gear unit	40G	8063583	EAMM-A-N38-40G
Third-party gear unit	50GA	8063584	EAMM-A-N38-50GA
Third-party gear unit	56GA	8063585	EAMM-A-N38-56GA
Third-party gear unit	70GA	8063586	EAMM-A-N38-70GA
Third-party gear unit	68GA	8063587	EAMM-A-N38-68GA
Third-party gear unit	72GA	8063588	EAMM-A-N38-72GA

1) The input torque must not exceed the max. permissible transferable torque of the axial kit.



Product range overview

Permissible axis/motor combinations with toothed belt axis ELGA-TB-...

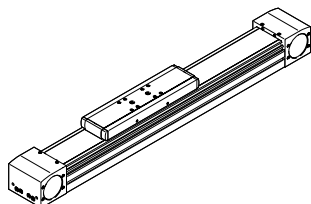

Table of interfaces for third-party motors

→ from page 58

Technical data for axial kits

→ from page 62

Motor/gear unit ¹⁾ Type	Motor interface	Axial kit	
		Part no.	Type
ELGA-TB-...-80			
With servo motor			
Third-party motor	60PA	8063590	EAMM-A-N48-60PA
Third-party motor	70AA	8063591	EAMM-A-N48-70AA
EMME-AS-80-..., third-party motor	80P	8063592	EAMM-A-N48-80P
Third-party motor	80PB	8107714	EAMM-A-N48-80PB
Third-party motor	88A	8063593	EAMM-A-N48-88A
Third-party motor	84AA	8063594	EAMM-A-N48-84AA
EMME-AS-100-..., third-party motor	100A	1201894	EAMM-A-N48-100A
Third-party motor	100A	1201894	EAMM-A-N48-100A
With servo motor and gear unit			
EMMT-AS-60-... EMGA-60-P-G...-EAS-60	60H	1456618	EAMM-A-N48-60H
EMME-AS-60-... EMGA-60-P-G...-EAS-60	60H	1456618	EAMM-A-N48-60H
EMME-AS-80-... EMGA-80-P-G...-EAS-80	80G	★ 1258793	EAMM-A-N48-80G
EMME-AS-100-... EMGA-80-P-G...-SAS-100	80G	★ 1258793	EAMM-A-N48-80G
With servo motor and angled gear unit			
EMMT-AS-60-... EMGA-60-A-G...-60P	60H	1456618	EAMM-A-N48-60H
EMME-AS-60-... EMGA-60-A-G...-60P	60H	1456618	EAMM-A-N48-60H
EMME-AS-80-... EMGA-80-A-G...-80P	80G	★ 1258793	EAMM-A-N48-80G
EMME-AS-100-... EMGA-80-A-G...-100A	80G	★ 1258793	EAMM-A-N48-80G

1) The input torque must not exceed the max. permissible transferable torque of the axial kit.

Festo core product range



Generally ready for shipping ex works in 24 hours

Generally ready for shipping ex works in 5 days

Product range overview

Permissible axis/motor combinations with toothed belt axis ELGA-TB-...

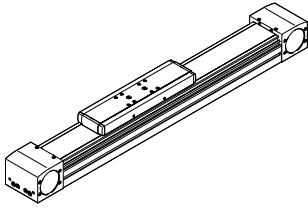

Table of interfaces for third-party motors

→ from page 58

Technical data for axial kits

→ from page 62

Motor/gear unit ¹⁾ Type	Motor interface	Axial kit	
		Part no.	Type
ELGA-TB-...-80			
With stepper motor and gear unit			
EMMS-ST-57-... EMGA-60-P-G...-SST-57	60G	★ 1972527	EAMM-A-N48-60G
EMMS-ST-87-... EMGA-80-P-G...-SST-87	80G	★ 1258793	EAMM-A-N48-80G
With integrated drive and gear unit			
EMCA-EC-67-... EMGC-60-...	60H	1456618	EAMM-A-N48-60H
With third-party gear unit			
Third-party gear unit	50GA	8063595	EAMM-A-N48-50GA
Third-party gear unit	56GA	8063596	EAMM-A-N48-56GA
Third-party gear unit	70GA	8063597	EAMM-A-N48-70GA
Third-party gear unit	75GA	8063598	EAMM-A-N48-75GA
Third-party gear unit	68GA	8063600	EAMM-A-N48-68GA
Third-party gear unit	72GA	8063601	EAMM-A-N48-72GA
Third-party gear unit	90GA	8063603	EAMM-A-N48-90GA
Third-party gear unit	120GA	8063605	EAMM-A-N48-120GA

1) The input torque must not exceed the max. permissible transferable torque of the axial kit.



Product range overview

Permissible axis/motor combinations with toothed belt axis ELGA-TB-...

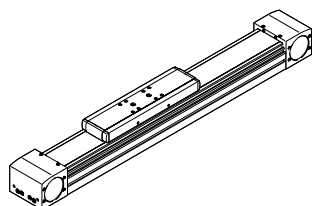

Table of interfaces for third-party motors

→ from page 58

Technical data for axial kits

→ from page 62

Motor/gear unit ¹⁾ Type	Motor interface	Axial kit	
		Part no.	Type
ELGA-TB-...-120			
With servo motor			
Third-party motor	84AA	8063606	EAMM-A-N80-84AA
Third-party motor	100A	8063607	EAMM-A-N80-100A
EMMS-AS-140-...	140A	1201691	EAMM-A-N80-140A
With servo motor and gear unit			
EMME-AS-80-... EMGA-80-P-G...-EAS-80	80G	★ 2372096	EAMM-A-N80-80G
EMME-AS-100-... EMGA-80-P-G...-SAS-100	80G	★ 2372096	EAMM-A-N80-80G
EMMS-AS-140-... EMGA-120-P-G...-SAS-140	120G	★ 1201695	EAMM-A-N80-120G
With servo motor and angled gear unit			
EMME-AS-80-... EMGA-80-A-G...-80P	80G	★ 2372096	EAMM-A-N80-80G
EMME-AS-100-... EMGA-80-A-G...-100A	80G	★ 2372096	EAMM-A-N80-80G
With stepper motor and gear unit			
EMMS-ST-87-... EMGA-80-P-G...-SST-87	80G	★ 2372096	EAMM-A-N80-80G
With third-party gear unit			
Third-party gear unit	70GA	8063608	EAMM-A-N80-70GA
Third-party gear unit	75GA	8063609	EAMM-A-N80-75GA
Third-party gear unit	68GA	8063611	EAMM-A-N80-68GA
Third-party gear unit	72GA	8063612	EAMM-A-N80-72GA
Third-party gear unit	90GA	8063614	EAMM-A-N80-90GA
Third-party gear unit	115GA	8063615	EAMM-A-N80-115GA
Third-party gear unit	120GA	8063617	EAMM-A-N80-120GA
Third-party gear unit	120GB	8063618	EAMM-A-N80-120GB
Third-party gear unit	120GC	8063619	EAMM-A-N80-120GC

1) The input torque must not exceed the max. permissible transferable torque of the axial kit.

Festo core product range



Generally ready for shipping ex works in 24 hours

Generally ready for shipping ex works in 5 days

Product range overview

Permissible axis/motor combinations with toothed belt axis ELGA-TB-...

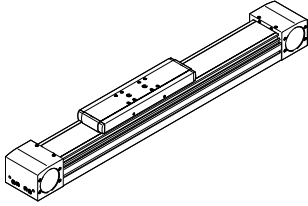

Table of interfaces for third-party motors

→ from page 58

Technical data for axial kits

→ from page 62

Motor/gear unit ¹⁾ Type	Motor interface	Axial kit	
		Part no.	Type
ELGA-TB-...-150			
With servo motor			
EMMS-AS-140-...	140A	3657226	EAMM-A-L95-140A-G2
EMMS-AS-190-...	190A	3659562	EAMM-A-L95-190A-G2
With servo motor and gear unit			
EMME-AS-80-... EMGA-80-P-G...-EAS-80	80G	3660191	EAMM-A-L95-80G-G2
EMME-AS-100-... EMGA-80-P-G...-SAS-100	80G	3660191	EAMM-A-L95-80G-G2
EMMS-AS-140-... EMGA-120-P-G...-SAS-140	120G	★ 3659941	EAMM-A-L95-120G-G2
With servo motor and angled gear unit			
EMME-AS-80-... EMGA-80-A-G...-80P	80G	3660191	EAMM-A-L95-80G-G2
EMME-AS-100-... EMGA-80-A-G...-100A	80G	3660191	EAMM-A-L95-80G-G2
With stepper motor and gear unit			
EMMS-ST-87-... EMGA-80-P-G...-SST-87	80G	3660191	EAMM-A-L95-80G-G2
With third-party gear unit			
Third-party gear unit	75GA	8063522	EAMM-A-L95-75GA
Third-party gear unit	68GA	8063524	EAMM-A-L95-68GA
Third-party gear unit	72GA	8063525	EAMM-A-L95-72GA
Third-party gear unit	90GA	8063526	EAMM-A-L95-90GA
Third-party gear unit	115GA	8063527	EAMM-A-L95-115GA
Third-party gear unit	120GA	8063529	EAMM-A-L95-120GA
Third-party gear unit	120GB	8063530	EAMM-A-L95-120GB
Third-party gear unit	120GC	8063531	EAMM-A-L95-120GC
Third-party gear unit	160G	8063532	EAMM-A-L95-160G

1) The input torque must not exceed the max. permissible transferable torque of the axial kit.



Product range overview

Permissible axis/motor combinations with spindle axis ELGA-BS-...

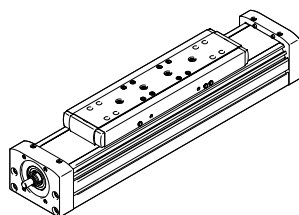

Table of interfaces for third-party motors

→ from page 58

Technical data for axial kits

→ from page 62

Motor/gear unit ¹⁾ Type	Motor interface	Axial kit	
		Part no.	Type
ELGA-BS-...-70			
With servo motor			
EMME-AS-40-...	40P	★ 3637972	EAMM-A-S38-40P-G2
Third-party motor	40A	3637971	EAMM-A-S38-40A-G2
Third-party motor	55A	3637967	EAMM-A-S38-55A-G2
Third-party motor	58AA	8105927	EAMM-A-S38-58AA
EMMT-AS-60-..., EMME-AS-60-..., third-party motor	60P	★ 3637958	EAMM-A-S38-60P-G2
Third-party motor	60R	8105923	EAMM-A-S38-60R
Third-party motor	60RA	8105924	EAMM-A-S38-60RA
With servo motor and gear unit			
EMME-AS-40-... EMGA-40-P-G...-EAS-40	40G	1456647	EAMM-A-S38-40G-G2
With servo motor and angled gear unit			
EMME-AS-40-... EMGA-40-A-G...-40P	40G	1456647	EAMM-A-S38-40G-G2
With stepper motor			
EMMS-ST-42-..., third-party motor	42A	★ 3637965	EAMM-A-S38-42A-G2
EMMS-ST-57-...	57A	★ 3637956	EAMM-A-S38-57A-G2
Third-party motor	60AA	8105926	EAMM-A-S38-60AA
With stepper motor and gear unit			
EMMS-ST-42-... EMGA-40-P-G...-SST-42	40G	1456647	EAMM-A-S38-40G-G2
With integrated drive			
EMCA-EC-67-...	67A	1456638	EAMM-A-S38-67A-G2
With integrated drive and gear unit			
EMCA-EC-67-... EMGC-40-...	40G	1456647	EAMM-A-S38-40G-G2
With third-party gear unit			
Third-party gear unit	50GA	8105922	EAMM-A-S38-50GA

1) The input torque must not exceed the max. permissible transferable torque of the axial kit.

Festo core product range



Generally ready for shipping ex works in 24 hours

Generally ready for shipping ex works in 5 days

Product range overview

Permissible axis/motor combinations with spindle axis ELGA-BS-...

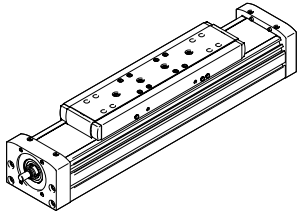

Table of interfaces for third-party motors

→ from page 58

Technical data for axial kits

→ from page 62

Motor/gear unit ¹⁾ Type	Motor interface	Axial kit	
		Part no.	Type
ELGA-BS-...-80			
With servo motor			
Third-party motor	55A	3637961	EAMM-A-S48-55A-G2
Third-party motor	58AA	8105933	EAMM-A-S48-58AA
EMMT-AS-60-..., EMME-AS-60-..., third-party motor	60P	★ 3637964	EAMM-A-S48-60P-G2
Third-party motor	60R	8105939	EAMM-A-S48-60R
Third-party motor	60RA	8105941	EAMM-A-S48-60RA
Third-party motor	70A	3637957	EAMM-A-S48-70A-G2
Third-party motor	70AA, 70AB	8105942	EAMM-A-S48-70AA
With servo motor and gear unit			
EMME-AS-40-... EMGA-40-P-G-...-EAS-40	40G	1456650	EAMM-A-S48-40G-G2
EMMT-AS-60-... EMGA-60-P-G-...-EAS-60	60H	1456652	EAMM-A-S48-60H-G2
EMME-AS-60-... EMGA-60-P-G-...-EAS-60	60H	1456652	EAMM-A-S48-60H-G2
With servo motor and angled gear unit			
EMME-AS-40-... EMGA-40-A-G-...-40P	40G	1456650	EAMM-A-S48-40G-G2
EMMT-AS-60-... EMGA-60-A-G-...-60P	60H	1456652	EAMM-A-S48-60H-G2
EMME-AS-60-... EMGA-60-A-G-...-60P	60H	1456652	EAMM-A-S48-60H-G2
With stepper motor			
EMMS-ST-57-... Third-party motor	57A	★ 3637963	EAMM-A-S48-57A-G2
EMMS-ST-87-... Third-party motor	60AA	8105935	EAMM-A-S48-60AA
EMMS-ST-87-... Third-party motor	87A	★ 3637962	EAMM-A-S48-87A-G2
With stepper motor and gear unit			
EMMS-ST-42-... EMGA-40-P-G-...-SST-42	40G	1456650	EAMM-A-S48-40G-G2
EMMS-ST-57-... EMGA-60-P-G-...-SST-57	60G	2256701	EAMM-A-S48-60G-G2
With integrated drive and gear unit			
EMCA-EC-67-... EMGC-40	40G	1456650	EAMM-A-S48-40G-G2
EMCA-EC-67-... EMGC-60-...	60H	1456652	EAMM-A-S48-60H-G2
With third-party gear unit			
Third-party gear unit	50GA	8105930	EAMM-A-S48-50GA

1) The input torque must not exceed the max. permissible transferable torque of the axial kit.



Product range overview

Permissible axis/motor combinations with spindle axis ELGA-BS-...

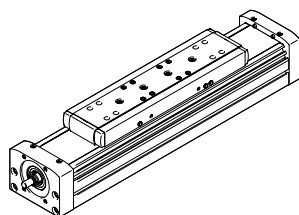

Table of interfaces for third-party motors

→ from page 58

Technical data for axial kits

→ from page 62

Motor/gear unit ¹⁾ Type	Motor interface	Axial kit	
		Part no.	Type
ELGA-BS-...-120			
Third-party motor	70A	3637959	EAMM-A-S62-70A-G2
EMME-AS-80-..., third-party motor	80P	★ 3637970	EAMM-A-S62-80P-G2
Third-party motor	80PB, 80R	8110208	EAMM-A-S62-80PB
Third-party motor	82AA	8110211	EAMM-A-S62-82AA
Third-party motor	84AA	8110226	EAMM-A-S62-84AA
EMME-AS-100-..., third-party motor	100A	★ 3637960	EAMM-A-S62-100A-G2
EMMS-AS-140-...	140A	3637969	EAMM-A-S62-140A-G2
With servo motor and gear unit			
EMMT-AS-60-... EMGA-60-P-G...-EAS-60	60H	1456654	EAMM-A-S62-60H-G2
EMME-AS-60-... EMGA-60-P-G...-EAS-60	60H	1456654	EAMM-A-S62-60H-G2
EMME-AS-80-... EMGA-80-P-G...-EAS-80	80G	1972530	EAMM-A-S62-80G-G2
EMME-AS-100-... EMGA-80-P-G...-SAS-100	80G	1972530	EAMM-A-S62-80G-G2
With servo motor and angled gear unit			
EMMT-AS-60-... EMGA-60-A-G...-60P	60H	1456654	EAMM-A-S62-60H-G2
EMME-AS-60-... EMGA-60-A-G...-60P	60H	1456654	EAMM-A-S62-60H-G2
EMME-AS-80-... EMGA-80-A-G...-80P	80G	1972530	EAMM-A-S62-80G-G2
EMME-AS-100-... EMGA-80-A-G...-100A	80G	1972530	EAMM-A-S62-80G-G2

1) The input torque must not exceed the max. permissible transferable torque of the axial kit.

Festo core product range



Generally ready for shipping ex works in 24 hours

Generally ready for shipping ex works in 5 days

Product range overview

Permissible axis/motor combinations with spindle axis ELGA-BS-...

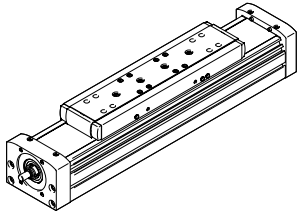

Table of interfaces for third-party motors

→ from page 58

Technical data for axial kits

→ from page 62

Motor/gear unit ¹⁾ Type	Motor interface	Axial kit	
		Part no.	Type
ELGA-BS-...-120			
With stepper motor			
EMMS-ST-87-...	87A	★ 3637966	EAMM-A-S62-87A-G2
With stepper motor and gear unit			
EMMS-ST-57-... EMGA-60-P-G...-SST-57	60G	2297649	EAMM-A-S62-60G-G2
EMMS-ST-87-... EMGA-80-P-G...-SST-87	80G	1972530	EAMM-A-S62-80G-G2
With integrated drive and gear unit			
EMCA-EC-67-... EMGC-60-...	60H	1456654	EAMM-A-S62-60H-G2
With third-party gear unit			
Third-party gear unit	70GA	8110082	EAMM-A-S62-70GA
ELGA-BS-...-150			
With servo motor			
EMME-AS-100-..., third-party motor	100A	3637955	EAMM-A-S95-100A-G2
EMMS-AS-140-...	140A	3637954	EAMM-A-S95-140A-G2
With third-party gear unit			
Third-party gear unit	90GA	8100066	EAMM-A-S95-90GA

1) The input torque must not exceed the max. permissible transferable torque of the axial kit.

Festo core product range



Generally ready for shipping ex works in 24 hours

Generally ready for shipping ex works in 5 days

Product range overview

Permissible axis/motor combinations with spindle axis ELGT-BS-...

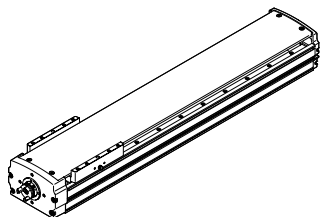

Table of interfaces for third-party motors

→ from page 58

Technical data for axial kits

→ from page 62

Motor ¹⁾ Type	Motor interface	Axial kit	
		Part no.	Type
ELGT-BS-...-90/-120/-160			
With servo motor			
EMMT-AS-60-..., EMME-AS-60-..., third-party motor	60P, 60PA	4824833	EAMM-A-T46-60P
Third-party motor	60R	8126174	EAMM-A-T46-60R
Third-party motor	60RA	8126174	EAMM-A-T46-60RA
Third-party motor	70AA, 70AB	8096057	EAMM-A-T46-70AA
EMME-AS-80-..., third-party motor	80P	4624170	EAMM-A-T46-80P
Third-party motor	80PA, 80RA	8091047	EAMM-A-T46-80PA
Third-party motor	80PB, 80R	8096175	EAMM-A-T46-80PB
EMME-AS-100-..., third-party motor	100A	4624227	EAMM-A-T46-100A
With stepper motor			
Third-party motor	85AA	8096186	EAMM-A-T46-85AA
EMMS-ST-87-...	87A	4048771	EAMM-A-T46-87A
With integrated drive			
EMCA-EC-67-...	67A	8084495	EAMM-A-T46-67A

1) The input torque must not exceed the max. permissible transferable torque of the axial kit.

Product range overview

Permissible axis/motor combinations with toothed belt axis ELGC-TB-...

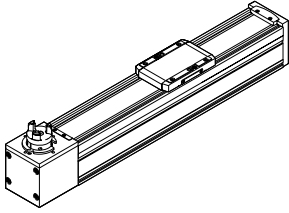

Table of interfaces for third-party motors

→ from page 58

Technical data for axial kits

→ from page 62

Motor ¹⁾ Type	Motor interface	Axial kit	
		Part no.	Type
ELGC-TB-...-45			
With servo motor			
Third-party motor	38AA	8093023	EAMM-A-V32-38AA
EMME-AS-40-...	40P	4595742	EAMM-A-V32-40P
Third-party motor	40R	8087090	EAMM-A-V32-40R
Third-party motor	40RA	8094180	EAMM-A-V32-40RA
Third-party motor	58AA	8098982	EAMM-A-V32-58AA
EMMT-AS-60-..., EMME-AS-60-..., third-party motor	60P	4608750	EAMM-A-V32-60P
Third-party motor	60PA	8091053	EAMM-A-V32-60PA
Third-party motor	60RA	8093041	EAMM-A-V32-60RA
With stepper motor			
EMMS-ST-42-..., third-party motor	42A	4281142	EAMM-A-V32-42A
Third-party motor	42AB	8094200	EAMM-A-V32-42AB
EMMS-ST-57-...	57A	4597016	EAMM-A-V32-57A
Third-party motor	60AA	8092271	EAMM-A-V32-60AA
ELGC-TB-...-60			
With servo motor			
Third-party motor	58AA	8094935	EAMM-A-T42-58AA
EMMT-AS-60-..., EMME-AS-60-..., third-party motor	60P, 60PA	4133487	EAMM-A-T42-60P
Third-party motor	60R	8093289	EAMM-A-T42-60R
Third-party motor	60RA	8092264	EAMM-A-T42-60RA
EMME-AS-80-...	80P	4623788	EAMM-A-T42-80P
With stepper motor			
EMMS-ST-57-...	57A	4327034	EAMM-A-T42-57A
Third-party motor	60AA	8092255	EAMM-A-T42-60AA
Third-party motor	60AB	8094949	EAMM-A-T42-60AB
EMMS-ST-87-...	87A	4610008	EAMM-A-T42-87A
With integrated drive			
EMCA-EC-67-...	67A	8084497	EAMM-A-T42-67A

1) The input torque must not exceed the max. permissible transferable torque of the axial kit.

Product range overview

Permissible axis/motor combinations with toothed belt axis ELGC-TB-...

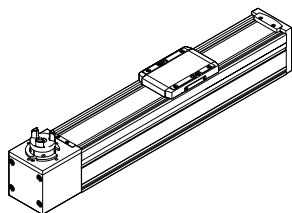

Table of interfaces for third-party motors

→ from page 58

Technical data for axial kits

→ from page 62

Motor ¹⁾ Type	Motor interface	Axial kit	
		Part no.	Type
ELGC-TB-...-80			
With servo motor			
EMMT-AS-60-..., EMME-AS-60-..., third-party motor	60P, 60PA	4824833	EAMM-A-T46-60P
Third-party motor	60R	8126174	EAMM-A-T46-60R
Third-party motor	60RA	8126174	EAMM-A-T46-60RA
Third-party motor	70AA, 70AB	8096057	EAMM-A-T46-70AA
EMME-AS-80-..., third-party motor	80P	4624170	EAMM-A-T46-80P
Third-party motor	80PA, 80RA	8091047	EAMM-A-T46-80PA
Third-party motor	80PB, 80R	8096175	EAMM-A-T46-80PB
EMME-AS-100-..., third-party motor	100A	4624227	EAMM-A-T46-100A
With stepper motor			
Third-party motor	85AA	8096186	EAMM-A-T46-85AA
EMMS-ST-87-...	87A	4048771	EAMM-A-T46-87A
With integrated drive			
EMCA-EC-67-...	67A	8084495	EAMM-A-T46-67A

1) The input torque must not exceed the max. permissible transferable torque of the axial kit.

Product range overview

Permissible axis/motor combinations with spindle axis ELGC-BS-...

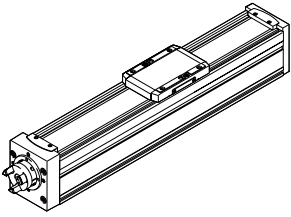

Table of interfaces for third-party motors

→ from page 58

Technical data for axial kits

→ from page 62

Motor ¹⁾ Type	Motor interface	Axial kit	
		Part no.	Type
ELGC-BS-...-32			
With servo motor			
Third-party motor	38AA	8093162	EAMM-A-V25-38AA
EMME-AS-40-..., third-party motor	40P	4491059	EAMM-A-V25-40P
Third-party motor	40R	8087062	EAMM-A-V25-40R
Third-party motor	40RA	8094100	EAMM-A-V25-40RA
With stepper motor			
EMMS-ST-42-..., third-party motor	42A	4582608	EAMM-A-V25-42A
Third-party motor	42AB	8094108	EAMM-A-V25-42AB
ELGC-BS-...-45			
With servo motor			
Third-party motor	38AA	8093023	EAMM-A-V32-38AA
EMME-AS-40-...	40P	4595742	EAMM-A-V32-40P
Third-party motor	40R	8087090	EAMM-A-V32-40R
Third-party motor	40RA	8094180	EAMM-A-V32-40RA
Third-party motor	58AA	8098982	EAMM-A-V32-58AA
EMMT-AS-60-..., EMME-AS-60-..., third-party motor	60P	4608750	EAMM-A-V32-60P
Third-party motor	60PA	8091053	EAMM-A-V32-60PA
Third-party motor	60RA	8093041	EAMM-A-V32-60RA
With stepper motor			
EMMS-ST-42-..., third-party motor	42A	4281142	EAMM-A-V32-42A
Third-party motor	42AB	8094200	EAMM-A-V32-42AB
EMMS-ST-57-...	57A	4597016	EAMM-A-V32-57A
Third-party motor	60AA	8092271	EAMM-A-V32-60AA
ELGC-BS-...-60			
With servo motor			
Third-party motor	58AA	8094935	EAMM-A-T42-58AA
EMMT-AS-60-..., EMME-AS-60-..., third-party motor	60P, 60PA	4133487	EAMM-A-T42-60P
Third-party motor	60R	8093289	EAMM-A-T42-60R
Third-party motor	60RA	8092264	EAMM-A-T42-60RA
EMME-AS-80-..., third-party motor	80P	4623788	EAMM-A-T42-80P
With stepper motor			
EMMS-ST-57-...	57A	4327034	EAMM-A-T42-57A
Third-party motor	60AA	8092255	EAMM-A-T42-60AA
Third-party motor	60AB	8094949	EAMM-A-T42-60AB
EMMS-ST-87-...	87A	4610008	EAMM-A-T42-87A
With integrated drive			
EMCA-EC-67-...	67A	8084497	EAMM-A-T42-67A

1) The input torque must not exceed the max. permissible transferable torque of the axial kit.

Product range overview

Permissible axis/motor combinations with spindle axis ELGC-BS-...

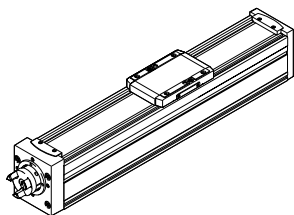

Table of interfaces for third-party motors

→ from page 58

Technical data for axial kits

→ from page 62

Motor ¹⁾ Type	Motor interface	Axial kit	
		Part no.	Type
ELGC-BS-...-80			
With servo motor			
EMMT-AS-60-..., EMME-AS-60-..., third-party motor	60P	4824833	EAMM-A-T46-60P
Third-party motor	70AA	8096057	EAMM-A-T46-70AA
EMME-AS-80-..., third-party motor	80P	4624170	EAMM-A-T46-80P
Third-party motor	80PA	8091047	EAMM-A-T46-80PA
Third-party motor	80PB	8096175	EAMM-A-T46-80PB
EMME-AS-100-..., third-party motor	100A	4624227	EAMM-A-T46-100A
Third-party motor	100A	4624227	EAMM-A-T46-100A
With stepper motor			
Third-party motor	85AA	8096186	EAMM-A-T46-85AA
EMMS-ST-87-...	87A	4048771	EAMM-A-T46-87A
With integrated drive			
EMCA-EC-67-...	67A	8084495	EAMM-A-T46-67A

1) The input torque must not exceed the max. permissible transferable torque of the axial kit.

Product range overview

Permissible axis/motor combinations with toothed belt axis EGC-HD-TB

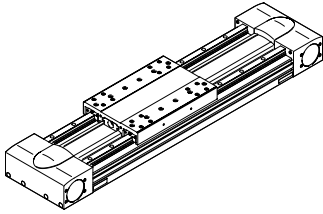

Table of interfaces for third-party motors

→ from page 58

Technical data for axial kits

→ from page 62

Motor/gear unit ¹⁾ Type	Motor interface	Axial kit	
		Part no.	Type
EGC-HD-125-...-TB			
With servo motor			
Third-party motor	55A	8063533	EAMM-A-M43-55A
Third-party motor	70A	8063534	EAMM-A-M43-70A
Third-party motor	70AA, 70AB	8063535	EAMM-A-M43-70AA
Third-party motor	90R	8063537	EAMM-A-M43-90R
Third-party motor	92RA	8063538	EAMM-A-M43-90RA
With servo motor and gear unit			
EMMT-AS-60-... EMGA-60-P-G...-EAS-60	60H	1456612	EAMM-A-M43-60H
EMME-AS-60-... EMGA-60-P-G...-EAS-60	60H	1456612	EAMM-A-M43-60H
With servo motor and angled gear unit			
EMMT-AS-60-... EMGA-60-A-G...-60P	60H	1456612	EAMM-A-M43-60H
EMME-AS-60-... EMGA-60-A-G...-60P	60H	1456612	EAMM-A-M43-60H
With stepper motor and gear unit			
EMMS-ST-57-... EMGA-60-P-G...-SST-57	60G	1190076	EAMM-A-M43-60G
With integrated drive and gear unit			
EMCA-EC-67-... EMGC-60-...	60H	1456612	EAMM-A-M43-60H
With third-party gear unit			
Third-party gear unit	40G	8063539	EAMM-A-M43-40G
Third-party gear unit	50GA	8063540	EAMM-A-M43-50GA
Third-party gear unit	56GA	8063541	EAMM-A-M43-56GA
Third-party gear unit	68GA	8063544	EAMM-A-M43-68GA
Third-party gear unit	70GA	8063542	EAMM-A-M43-70GA
Third-party gear unit	72GA	8063545	EAMM-A-M43-72GA

1) The input torque must not exceed the max. permissible transferable torque of the axial kit.

Product range overview

Permissible axis/motor combinations with toothed belt axis EGC-HD-TB

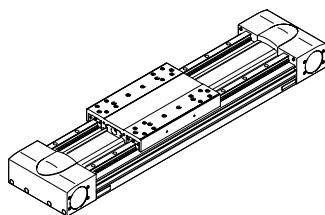

Table of interfaces for third-party motors

→ from page 58

Technical data for axial kits

→ from page 62

Motor/gear unit ¹⁾ Type	Motor interface	Axial kit	
		Part no.	Type
EGC-HD-160-...-TB			
With servo motor			
Third-party motor	84AA	8063548	EAMM-A-M48-84AA
Third-party motor	88A	8063547	EAMM-A-M48-88A
With servo motor and gear unit			
EMMT-AS-60-... EMGA-60-P-G...-EAS-60	60H	1456614	EAMM-A-M48-60H
EMME-AS-60-... EMGA-60-P-G...-EAS-60	60H	1456614	EAMM-A-M48-60H
EMME-AS-80-... EMGA-80-P-G...-EAS-80	80G	1190421	EAMM-A-M48-80G
EMME-AS-100-... EMGA-80-P-G...-SAS-100	80G	1190421	EAMM-A-M48-80G
With servo motor and angled gear unit			
EMMT-AS-60-... EMGA-60-A-G...-60P	60H	1456614	EAMM-A-M48-60H
EMME-AS-60-... EMGA-60-A-G...-60P	60H	1456614	EAMM-A-M48-60H
EMME-AS-80-... EMGA-80-A-G...-80P	80G	1190421	EAMM-A-M48-80G
EMME-AS-100-... EMGA-80-A-G...-100A	80G	1190421	EAMM-A-M48-80G
With stepper motor and gear unit			
EMMS-ST-87-... EMGA-80-P-G...-SST-87	80G	1190421	EAMM-A-M48-80G
With integrated drive and gear unit			
EMCA-EC-67-... EMGC-60-...	60H	1456614	EAMM-A-M48-60H
With third-party gear unit			
Third-party gear unit	40G	8063549	EAMM-A-M48-40G
Third-party gear unit	50GA	8063550	EAMM-A-M48-50GA
Third-party gear unit	56GA	8063551	EAMM-A-M48-56GA
Third-party gear unit	60G	8063552	EAMM-A-M48-60G
Third-party gear unit	70GA	8063553	EAMM-A-M48-70GA
Third-party gear unit	75GA	8063554	EAMM-A-M48-75GA
Third-party gear unit	68GA	8063556	EAMM-A-M48-68GA
Third-party gear unit	72GA	8063557	EAMM-A-M48-72GA
Third-party gear unit	90GA	8063558	EAMM-A-M48-90GA
Third-party gear unit	120GA	8063561	EAMM-A-M48-120GA

1) The input torque must not exceed the max. permissible transferable torque of the axial kit.

Product range overview

Permissible axis/motor combinations with toothed belt axis EGC-HD-TB

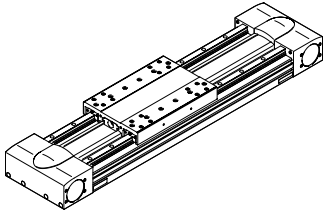

Table of interfaces for third-party motors

→ from page 58

Technical data for axial kits

→ from page 62

Motor/gear unit ¹⁾ Type	Motor interface	Axial kit	
		Part no.	Type
EGC-HD-220-...-TB			
With servo motor			
Third-party motor	84AA	8063563	EAMM-A-M80-84AA
With servo motor and gear unit			
EMME-AS-100-... EMGA-120-P-G...-SAS-100	120G	1190774	EAMM-A-M80-120G
EMMS-AS-140-... EMGA-120-P-G...-SAS-140	120G	1190774	EAMM-A-M80-120G
With third-party gear unit			
Third-party gear unit	75GA	8063564	EAMM-A-M80-75GA
Third-party gear unit	80G	8063565	EAMM-A-M80-80G
Third-party gear unit	68GA	8063566	EAMM-A-M80-68GA
Third-party gear unit	90GA	8063568	EAMM-A-M80-90GA
Third-party gear unit	115GA	8063569	EAMM-A-M80-115GA
Third-party gear unit	120GA	8063571	EAMM-A-M80-120GA
Third-party gear unit	120GB	8063572	EAMM-A-M80-120GB
Third-party gear unit	120GC	8063573	EAMM-A-M80-120GC

1) The input torque must not exceed the max. permissible transferable torque of the axial kit.

Product range overview

Permissible axis/motor combinations with spindle axis EGC-HD-BS

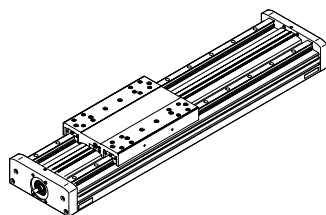

Table of interfaces for third-party motors

→ from page 58

Technical data for axial kits

→ from page 62

Motor/gear unit ¹⁾ Type	Motor interface	Axial kit	
		Part no.	Type
EGC-HD-125-...-BS			
With servo motor			
EMME-AS-40-...	40P	★ 3637972	EAMM-A-S38-40P-G2
Third-party motor	40A	3637971	EAMM-A-S38-40A-G2
Third-party motor	55A	3637967	EAMM-A-S38-55A-G2
Third-party motor	58AA	8105927	EAMM-A-S38-58AA
EMMT-AS-60-..., EMME-AS-60-..., third-party motor	60P	★ 3637958	EAMM-A-S38-60P-G2
Third-party motor	60R	8105923	EAMM-A-S38-60R
Third-party motor	60RA	8105924	EAMM-A-S38-60RA
With servo motor and gear unit			
EMME-AS-40-... EMGA-40-P-G...-EAS-40	40G	1456647	EAMM-A-S38-40G-G2
With servo motor and angled gear unit			
EMME-AS-40-... EMGA-40-A-G...-40P	40G	1456647	EAMM-A-S38-40G-G2
With stepper motor			
EMMS-ST-42-..., third-party motor	42A	★ 3637965	EAMM-A-S38-42A-G2
EMMS-ST-57-...	57A	★ 3637956	EAMM-A-S38-57A-G2
Third-party motor	60AA	8105926	EAMM-A-S38-60AA
With stepper motor and gear unit			
EMMS-ST-42-... EMGA-40-P-G...-SST-42	40G	1456647	EAMM-A-S38-40G-G2
With integrated drive			
EMCA-EC-67-...	67A	1456638	EAMM-A-S38-67A-G2
With integrated drive and gear unit			
EMCA-EC-67-... EMGC-40-...	40G	1456647	EAMM-A-S38-40G-G2
With third-party gear unit			
Third-party gear unit	50GA	8105922	EAMM-A-S38-50GA

1) The input torque must not exceed the max. permissible transferable torque of the axial kit.

Festo core product range



Generally ready for shipping ex works in 24 hours

Generally ready for shipping ex works in 5 days

Product range overview

Permissible axis/motor combinations with spindle axis EGC-HD-BS

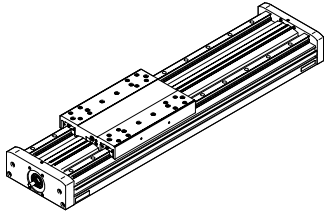

Table of interfaces for third-party motors

→ from page 58

Technical data for axial kits

→ from page 62

Motor/gear unit ¹⁾ Type	Motor interface	Axial kit	
		Part no.	Type
EGC-HD-160-...-BS			
With servo motor			
Third-party motor	55A	3637961	EAMM-A-S48-55A-G2
Third-party motor	58AA	8105933	EAMM-A-S48-58AA
EMMT-AS-60-..., EMME-AS-60-..., third-party motor	60P	★ 3637964	EAMM-A-S48-60P-G2
Third-party motor	60R	8105939	EAMM-A-S48-60R
Third-party motor	60RA	8105941	EAMM-A-S48-60RA
Third-party motor	70A	3637957	EAMM-A-S48-70A-G2
Third-party motor	70AA, 70AB	8105942	EAMM-A-S48-70AA
With servo motor and gear unit			
EMME-AS-40-... EMGA-40-P-G...-EAS-40	40G	1456650	EAMM-A-S48-40G-G2
EMMT-AS-60-... EMGA-60-P-G...-EAS-60	60H	1456652	EAMM-A-S48-60H-G2
EMME-AS-60-... EMGA-60-P-G...-EAS-60	60H	1456652	EAMM-A-S48-60H-G2
With servo motor and angled gear unit			
EMME-AS-40-... EMGA-40-A-G...-40P	40G	1456650	EAMM-A-S48-40G-G2
EMMT-AS-60-... EMGA-60-A-G...-60P	60H	1456652	EAMM-A-S48-60H-G2
EMME-AS-60-... EMGA-60-A-G...-60P	60H	1456652	EAMM-A-S48-60H-G2
With stepper motor			
EMMS-ST-57-...	57A	★ 3637963	EAMM-A-S48-57A-G2
Third-party motor	60AA	8105935	EAMM-A-S48-60AA
EMMS-ST-87-...	87A	★ 3637962	EAMM-A-S48-87A-G2
With stepper motor and gear unit			
EMMS-ST-42-... EMGA-40-P-G...-SST-42	40G	1456650	EAMM-A-S48-40G-G2
EMMS-ST-57-... EMGA-60-P-G...-SST-57	60G	2256701	EAMM-A-S48-60G-G2
With integrated drive and gear unit			
EMCA-EC-67-... EMGC-40-...	40G	1456650	EAMM-A-S48-40G-G2
EMCA-EC-67-... EMGC-60-...	60H	1456652	EAMM-A-S48-60H-G2
With third-party gear unit			
Third-party gear unit	50GA	8105930	EAMM-A-S48-50GA

1) The input torque must not exceed the max. permissible transferable torque of the axial kit.



Product range overview

Permissible axis/motor combinations with spindle axis EGC-HD-BS

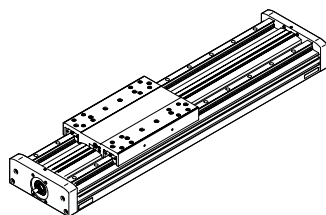

Table of interfaces for third-party motors

→ from page 58

Technical data for axial kits

→ from page 62

Motor/gear unit ¹⁾ Type	Motor interface	Axial kit	
		Part no.	Type
EGC-HD-220-...-BS			
With servo motor			
Third-party motor	70A	3637959	EAMM-A-S62-70A-G2
EMME-AS-80-..., third-party motor	80P	★ 3637970	EAMM-A-S62-80P-G2
Third-party motor	80PB, 80R	8110208	EAMM-A-S62-80PB
Third-party motor	82AA	8110211	EAMM-A-S62-82AA
Third-party motor	84AA	8110226	EAMM-A-S62-84AA
EMME-AS-100-..., third-party motor	100A	★ 3637960	EAMM-A-S62-100A-G2
EMMS-AS-140-...	140A	3637969	EAMM-A-S62-140A-G2
With servo motor and gear unit			
EMMT-AS-60-... EMGA-60-P-G...-EAS-60	60H	1456654	EAMM-A-S62-60H-G2
EMME-AS-60-... EMGA-60-P-G...-EAS-60	60H	1456654	EAMM-A-S62-60H-G2
EMME-AS-80-... EMGA-80-P-G...-EAS-80	80G	1972530	EAMM-A-S62-80G-G2
EMME-AS-100-... EMGA-80-P-G...-SAS-100	80G	1972530	EAMM-A-S62-80G-G2
With servo motor and angled gear unit			
EMMT-AS-60-... EMGA-60-A-G...-60P	60H	1456654	EAMM-A-S62-60H-G2
EMME-AS-60-... EMGA-60-A-G...-60P	60H	1456654	EAMM-A-S62-60H-G2
EMME-AS-80-... EMGA-80-A-G...-80P	80G	1972530	EAMM-A-S62-80G-G2
EMME-AS-100-... EMGA-80-A-G...-100A	80G	1972530	EAMM-A-S62-80G-G2
With stepper motor			
EMMS-ST-87-...	87A	★ 3637966	EAMM-A-S62-87A-G2
With stepper motor and gear unit			
EMMS-ST-57-... EMGA-60-P-G...-SST-57	60G	2297649	EAMM-A-S62-60G-G2
EMMS-ST-87-... EMGA-80-P-G...-SST-87	80G	1972530	EAMM-A-S62-80G-G2
With integrated drive and gear unit			
EMCA-EC-67-... EMGC-60-...	60H	1456654	EAMM-A-S62-60H-G2
EMCA-EC-67-... EMGC-80-...	80G	1972530	EAMM-A-S62-80G-G2
With third-party gear unit			
Third-party gear unit	70GA	8110082	EAMM-A-S62-70GA

1) The input torque must not exceed the max. permissible transferable torque of the axial kit.

Festo core product range



Generally ready for shipping ex works in 24 hours

Generally ready for shipping ex works in 5 days

Product range overview

Permissible axis/motor combinations with cantilever axis ELCC-TB-...

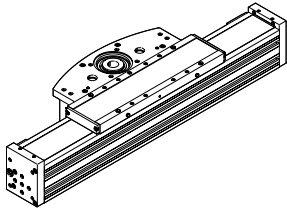

Table of interfaces for third-party motors

→ from page 58

Technical data for axial kits

→ from page 62

Motor/gear unit ¹⁾ Type	Motor interface	Axial kit	
		Part no.	Type
ELCC-TB-...-60			
With servo motor			
EMME-AS-80-..., third-party motor	80P	8063592	EAMM-A-N48-80P
With servo motor and gear unit			
EMMT-AS-60-... EMGA-60-P-G3-EAS-60	60H	1456618	EAMM-A-N48-60H
EMME-AS-60-... EMGA-60-P-G3-EAS-60	60H	1456618	EAMM-A-N48-60H
EMME-AS-80-... EMGA-80-P-G3-EAS-80	80G	1258793	EAMM-A-N48-80G
With servo motor and angled gear unit			
EMMT-AS-60-... EMGA-60-A-G3-60P	60H	1456618	EAMM-A-N48-60H
EMME-AS-60-... EMGA-60-A-G3-60P	60H	1456618	EAMM-A-N48-60H
EMME-AS-80-... EMGA-80-A-G3-80P	80G	1258793	EAMM-A-N48-80G
ELCC-TB-...-70			
With servo motor			
EMME-AS-100-..., third-party motor	100A	1201894	EAMM-A-N48-100A
With servo motor and gear unit			
EMME-AS-80-... EMGA-80-P-G3-EAS-80	80G	1258793	EAMM-A-N48-80G
EMME-AS-100-... EMGA-80-P-G3-SAS-100	80G	1258793	EAMM-A-N48-80G
With servo motor and angled gear unit			
EMME-AS-80-... EMGA-80-A-G3-80P	80G	1258793	EAMM-A-N48-80G
EMME-AS-100-... EMGA-80-A-G3-100A	80G	1258793	EAMM-A-N48-80G

1) The input torque must not exceed the max. permissible transferable torque of the axial kit.

Product range overview

Permissible axis/motor combinations with cantilever axis ELCC-TB-...

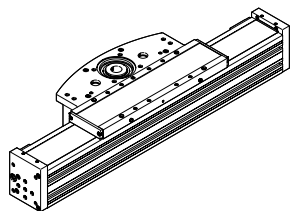

Table of interfaces for third-party motors

→ from page 58

Technical data for axial kits

→ from page 62

Motor/gear unit ¹⁾ Type	Motor interface	Axial kit	
		Part no.	Type
ELCC-TB-...-90			
With servo motor			
EMMS-AS-140-...	140A	1201691	EAMM-A-N80-140A
With servo motor and gear unit			
EMME-AS-100-... EMGA-80-P-G3-SAS-100	80G	2372096	EAMM-A-N80-80G
EMME-AS-100-... EMGA-80-P-G5-SAS-100	80G	2372096	EAMM-A-N80-80G
With servo motor and angled gear unit			
EMME-AS-100-... EMGA-80-A-...-100A	80G	2372096	EAMM-A-N80-80G
ELCC-TB-...-110			
With servo motor and gear unit			
EMME-AS-100-... EMGA-80-P-G5-SAS-100	80G	3660191	EAMM-A-L95-80G-G2
EMMS-AS-140-... EMGA-120-P-G3-SAS-140	120G	3659941	EAMM-A-L95-120G-G2
With servo motor and angled gear unit			
EMME-AS-100-... EMGA-80-A-G3-100A	80G	3660191	EAMM-A-L95-80G-G2

1) The input torque must not exceed the max. permissible transferable torque of the axial kit.

Product range overview

Permissible axis/motor combinations with mini slide EGSL

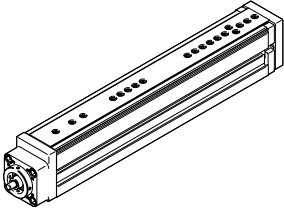

Table of interfaces for third-party motors

→ from page 58

Technical data for axial kits

→ from page 62

Motor/gear unit ¹⁾ Type	Motor interface	Axial kit	
		Part no.	Type
EGSL-35			
With servo motor			
Third-party motor	38AA	8105863	EAMM-A-D19-38AA
EMME-AS-40-...	40P	1981953	EAMM-A-D19-40P
Third-party motor	40A	1199152	EAMM-A-D19-40A
Third-party motor	40R	8105867	EAMM-A-D19-40R
With stepper motor			
EMMS-ST-28-...	28A	1081659	EAMM-A-D19-28A
EMMS-ST-42-..., third-party motor	42A	1087642	EAMM-A-D19-42A

1) The input torque must not exceed the max. permissible transferable torque of the axial kit.

Product range overview

Permissible axis/motor combinations with mini slide EGSL

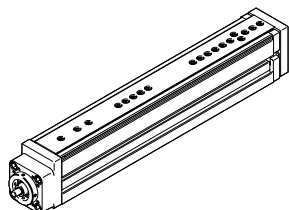

Table of interfaces for third-party motors

→ from page 58

Technical data for axial kits

→ from page 62

Motor/gear unit ¹⁾ Type	Motor interface	Axial kit	
		Part no.	Type
EGSL-45			
With servo motor			
EMME-AS-40-...	40P	★ 1976465	EAMM-A-D32-40P
Third-party motor	40R	8105826	EAMM-A-D32-40R
Third-party motor	40RA	8125610	EAMM-A-D32-40RA
Third-party motor	55A	550979	EAMM-A-D32-55A
Third-party motor	58AA	8105884	EAMM-A-D32-58AA
EMMT-AS-60-..., EMME-AS-60-..., third-party motor	60P	★ 1956054	EAMM-A-D32-60P
Third-party motor	60R	8105918	EAMM-A-D32-60R
Third-party motor	60RA	8105889	EAMM-A-D32-60RA
With servo motor and gear unit			
EMME-AS-40-... EMGA-40-P-G...-EAS-40	40G	1454238	EAMM-A-D32-40G
EMMT-AS-60-... EMGA-60-P-G...-EAS-60	60H	2946760	EAMM-A-D32-60H
EMME-AS-60-... EMGA-60-P-G...-EAS-60	60H	2946760	EAMM-A-D32-60H
With servo motor and angled gear unit			
EMME-AS-40-... EMGA-40-A-G...-40P	40G	1454238	EAMM-A-D32-40G
EMMT-AS-60-... EMGA-60-A-G...-60P	60H	2946760	EAMM-A-D32-60H
EMME-AS-60-... EMGA-60-A-G...-60P	60H	2946760	EAMM-A-D32-60H
With stepper motor			
EMMS-ST-42-..., third-party motor	42A	★ 543148	EAMM-A-D32-42A
EMMS-ST-57-... Third-party motor	57A 60AA	★ 550980 8105887	EAMM-A-D32-57A EAMM-A-D32-60AA
With stepper motor and gear unit			
EMMS-ST-42-... EMGA-40-P-G...-SST-42	40G	1454238	EAMM-A-D32-40G
EMMS-ST-57-... EMGA-60-P-G...-SST-57	60G	2946758	EAMM-A-D32-60G
With integrated drive			
EMCA-EC-67-...	67A	1454239	EAMM-A-D32-67A
With integrated drive and gear unit			
EMCA-EC-67-... EMGC-40-...	40G	1454238	EAMM-A-D32-40G
EMCA-EC-67-... EMGC-60-...	60H	2946760	EAMM-A-D32-60H
With third-party gear unit			
Third-party gear unit	50GA	8117072	EAMM-A-D32-50GA

1) The input torque must not exceed the max. permissible transferable torque of the axial kit.

Festo core product range



Generally ready for shipping ex works in 24 hours

Generally ready for shipping ex works in 5 days

Product range overview

Permissible axis/motor combinations with mini slide EGSL

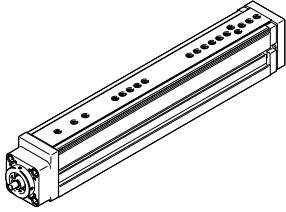

Table of interfaces for third-party motors

→ from page 58

Technical data for axial kits

→ from page 62

Motor/gear unit ¹⁾ Type	Motor interface	Axial kit	
		Part no.	Type
EGSL-55			
With servo motor			
Third-party motor	55A	543153	EAMM-A-D40-55A
Third-party motor	58AA	8105928	EAMM-A-D40-58AA
EMMT-AS-60-..., EMME-AS-60-..., third-party motor	60P	★ 1977000	EAMM-A-D40-60P
Third-party motor	60R	8117079	EAMM-A-D40-60R
Third-party motor	60RA	8117078	EAMM-A-D40-60RA
Third-party motor	70AA, 70AB	8105952	EAMM-A-D40-70AA
With servo motor and gear unit			
EMME-AS-40-...	40G	★ 560282	EAMM-A-D40-40G
EMGA-40-P-G...-EAS-40		2256398	EAMM-A-D40-40G-G2 ²⁾
EMMT-AS-60-...	60H	1454242	EAMM-A-D40-60H
EMGA-60-P-G...-EAS-60			
EMME-AS-60-...	60H	1454242	EAMM-A-D40-60H
EMGA-60-P-G...-EAS-60			
With servo motor and angled gear unit			
EMME-AS-40-...	40G	★ 560282	EAMM-A-D40-40G
EMGA-40-A-G...-40P		2256398	EAMM-A-D40-40G-G2 ²⁾
EMMT-AS-60-...	60H	1454242	EAMM-A-D40-60H
EMGA-60-A-G...-60P			
EMME-AS-60-...	60H	1454242	EAMM-A-D40-60H
EMGA-60-A-G...-60P			
With stepper motor			
EMMS-ST-57-...	57A	★ 543154	EAMM-A-D40-57A
Third-party motor	60AA	8105929	EAMM-A-D40-60AA
EMMS-ST-87-...	87A	★ 550982	EAMM-A-D40-87A
With stepper motor and gear unit			
EMMS-ST-42-...	40G	★ 560282	EAMM-A-D40-40G
EMGA-40-P-G...-SST-42		2256398	EAMM-A-D40-40G-G2 ²⁾
EMMS-ST-57-...	60G	2256400	EAMM-A-D40-60G
EMGA-60-P-G...-SST-57			
With integrated drive			
EMCA-EC-67-...	67A	1454243	EAMM-A-D40-67A
With integrated drive and gear unit			
EMCA-EC-67-...	40G	★ 560282	EAMM-A-D40-40G
EMGC-40-...		2256398	EAMM-A-D40-40G-G2 ²⁾
EMCA-EC-67-...	60H	1454242	EAMM-A-D40-60H
EMGC-60-...			
With third-party gear unit			
Third-party gear unit	50GA	8117076	EAMM-A-D40-50GA

1) The input torque must not exceed the max. permissible transferable torque of the axial kit.

2) The axial kit can be retrofitted from IP40 to IP65 with the help of a seal set EADS-F → page 1.

Festo core product range



Generally ready for shipping ex works in 24 hours

Generally ready for shipping ex works in 5 days

Product range overview

Permissible axis/motor combinations with mini slide EGSL

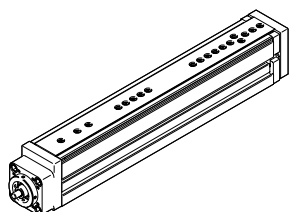

Table of interfaces for third-party motors

→ from page 58

Technical data for axial kits

→ from page 62

Motor/gear unit ¹⁾ Type	Motor interface	Axial kit	
		Part no.	Type
EGSL-75			
With servo motor			
Third-party motor	70A	543161	EAMM-A-D60-70A
EMME-AS-80-..., third-party motor	80P	★ 1977073	EAMM-A-D60-80P
Third-party motor	80PB, 80R	8105937	EAMM-A-D60-80PB
Third-party motor	84AA	8105945	EAMM-A-D60-84AA
EMME-AS-100-..., third-party motor	100A	★ 550983	EAMM-A-D60-100A
Third-party motor	100A	★ 550983	EAMM-A-D60-100A
With servo motor and gear unit			
EMMT-AS-60-...	60H	1454245	EAMM-A-D60-60H
EMGA-60-P-G...-EAS-60			
EMME-AS-60-...	60H	1454245	EAMM-A-D60-60H
EMGA-60-P-G...-EAS-60			
EMME-AS-80-...	80G	1499402	EAMM-A-D60-80G
EMGA-80-P-G...-EAS-80			
EMME-AS-100-...	80G	1499402	EAMM-A-D60-80G
EMGA-80-P-G...-SAS-100			
With servo motor and angled gear unit			
EMMT-AS-60-...	60H	1454245	EAMM-A-D60-60H
EMGA-60-A-G...-60P			
EMME-AS-60-...	60H	1454245	EAMM-A-D60-60H
EMGA-60-A-G...-60P			
EMME-AS-80-...	80G	1499402	EAMM-A-D60-80G
EMGA-80-A-G...-80P			
EMME-AS-100-...	80G	1499402	EAMM-A-D60-80G
EMGA-80-A-G...-100A			
With stepper motor			
EMMS-ST-87-...	87A	★ 543162	EAMM-A-D60-87A
With stepper motor and gear unit			
EMMS-ST-57-...	60G	★ 560283	EAMM-A-D60-60G
EMGA-60-P-G...-SST-57		2256696	EAMM-A-D60-60G-G2 ²⁾
EMMS-ST-87-...	80G	1499402	EAMM-A-D60-80G
EMGA-80-P-G...-SST-87			
With integrated drive and gear unit			
EMCA-EC-67-...	80H	1454245	EAMM-A-D60-80H
EMGC-60-...			
With third-party gear unit			
Third-party gear unit	90GA	8105944	EAMM-A-D60-90GA

1) The input torque must not exceed the max. permissible transferable torque of the axial kit.

2) The axial kit can be retrofitted from IP40 to IP65 with the help of a seal set EADS-F → page 1.

Festo core product range



Generally ready for shipping ex works in 24 hours

Generally ready for shipping ex works in 5 days

Product range overview

Permissible axis/motor combinations with mini slide EGSC

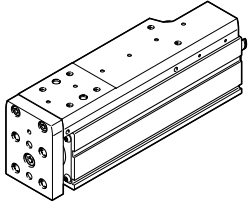

Table of interfaces for third-party motors

→ from page 58

Technical data for axial kits

→ from page 62

Motor ¹⁾ Type	Motor interface	Axial kit	
		Part no.	Type
EGSC-25			
With stepper motor			
EMMS-ST-28-...	28A	4505258	EAMM-A-V20-28A
Third-party motor	28AA	8093016	EAMM-A-V20-28AA
EGSC-32			
With servo motor			
Third-party motor	38AA	8093162	EAMM-A-V25-38AA
EMME-AS-40-...	40P	4491059	EAMM-A-V25-40P
Third-party motor	40R	8087062	EAMM-A-V25-40R
Third-party motor	40RA	8094100	EAMM-A-V25-40RA
With stepper motor			
Third-party motor	35A, 35AB	8093255	EAMM-A-V25-35A
EMMS-ST-42-..., third-party motor	42A	4582608	EAMM-A-V25-42A
Third-party motor	42AB	8094108	EAMM-A-V25-42AB
EGSC-45			
With servo motor			
Third-party motor	38AA	8093023	EAMM-A-V32-38AA
EMME-AS-40-...	40P	4595742	EAMM-A-V32-40P
Third-party motor	40R	8087090	EAMM-A-V32-40R
Third-party motor	40RA	8094180	EAMM-A-V32-40RA
Third-party motor	58AA	8098982	EAMM-A-V32-58AA
EMMT-AS-60-..., EMME-AS-60-..., third-party motor	60P	4608750	EAMM-A-V32-60P
Third-party motor	60PA	8091053	EAMM-A-V32-60PA
Third-party motor	60RA	8093041	EAMM-A-V32-60RA
With stepper motor			
EMMS-ST-42-..., third-party motor	42A	4281142	EAMM-A-V32-42A
Third-party motor	42AB	8094200	EAMM-A-V32-42AB
EMMS-ST-57-...	57A	4597016	EAMM-A-V32-57A
Third-party motor	60AA	8092271	EAMM-A-V32-60AA
EGSC-60			
With servo motor			
Third-party motor	58AA	8094935	EAMM-A-T42-58AA
EMMT-AS-60-..., EMME-AS-60-..., third-party motor	60P, 60PA	4133487	EAMM-A-T42-60P
Third-party motor	60R	8093289	EAMM-A-T42-60R
Third-party motor	60RA	8092264	EAMM-A-T42-60RA
EMME-AS-80-..., third-party motor	80P	4623788	EAMM-A-T42-80P
With stepper motor			
EMMS-ST-57-...	57A	4327034	EAMM-A-T42-57A
Third-party motor	60AA	8092255	EAMM-A-T42-60AA
Third-party motor	60AB	8094949	EAMM-A-T42-60AB
EMMS-ST-87-...	87A	4610008	EAMM-A-T42-87A
With integrated drive			
EMCA-EC-67-...	67A	8084497	EAMM-A-T42-67A

1) The input torque must not exceed the max. permissible transferable torque of the axial kit.

Product range overview

Permissible axis/motor combinations with electric slide EGSK

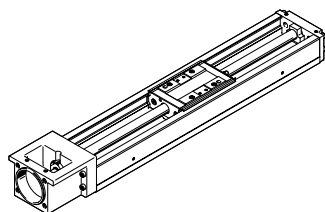

Table of interfaces for third-party motors

→ from page 58

Technical data for axial kits

→ from page 62

Motor/gear unit ¹⁾ Type	Motor interface	Axial kit	
		Part no.	Type
EGSK-15			
With servo motor			
EMME-AS-40-...	40P	1982886	EAMM-A-P3-28D-40P
With stepper motor			
EMMS-ST-28-...	28A	1703478	EAMM-A-P3-28D-28A
EGSK-20			
With servo motor			
EMME-AS-40-...	40P	1983071	EAMM-A-P4-28B-40P
Third-party motor	38AA	8107704	EAMM-A-P4-28B-38AA
Third-party motor	40A	562637	EAMM-A-P4-28B-40A
Third-party motor	40R	8107707	EAMM-A-P4-28B-40R
Third-party motor	40RA	8107708	EAMM-A-P4-28B-40RA
With stepper motor			
EMMS-ST-28-...	28A	1731466	EAMM-A-P4-28B-28A
EMMS-ST-42-..., third-party motor	42A	562636	EAMM-A-P4-28B-42A
EGSK-26			
With servo motor			
EMME-AS-40-...	40P	1983122	EAMM-A-P5-28B-40P
Third-party motor	38AA	8107710	EAMM-A-P5-28B-38AA
Third-party motor	40A	562641	EAMM-A-P5-28B-40A
Third-party motor	40R	8107711	EAMM-A-P5-28B-40R
Third-party motor	40RA	8107712	EAMM-A-P5-28B-40RA
With stepper motor			
EMMS-ST-28-...	28A	1731474	EAMM-A-P5-28B-28A
EMMS-ST-42-..., third-party motor	42A	562640	EAMM-A-P5-28B-42A
EGSK-33			
With servo motor			
EMME-AS-40-...	40P	1983450	EAMM-A-P6-38A-40P
Third-party motor	40A	562646	EAMM-A-P6-38A-40A
Third-party motor	55A	562647	EAMM-A-P6-38A-55A
Third-party motor	58AA	8123494	EAMM-A-P6-38A-58AA
EMMT-AS-60-..., EMME-AS-60-..., third-party motor	60P	2264375	EAMM-A-P6-38A-60P
Third-party motor	60R	8123495	EAMM-A-P6-38A-60R
Third-party motor	60RA	8123496	EAMM-A-P6-38A-60RA
With servo motor and gear unit			
EMME-AS-40-... EMGA-40-P-G-...-EAS-40	40G	2297645	EAMM-A-P6-38A-40G

1) The input torque must not exceed the max. permissible transferable torque of the axial kit.

Product range overview

Permissible axis/motor combinations with electric slide EGSK

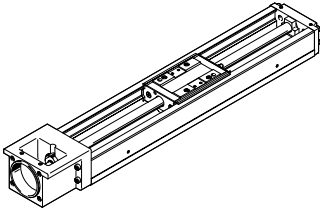

Table of interfaces for third-party motors

→ from page 58

Technical data for axial kits

→ from page 62

Motor/gear unit ¹⁾ Type	Motor interface	Axial kit	
		Part no.	Type
EGSK-33			
With stepper motor			
EMMS-ST-42-..., third-party motor	42A	562644	EAMM-A-P6-38A-42A
EMMS-ST-57-...	57A	562645	EAMM-A-P6-38A-57A
With stepper motor and gear unit			
EMMS-ST-42-... EMGA-40-P-G...-SST-42	40G	2297645	EAMM-A-P6-38A-40G
With integrated drive			
EMCA-EC-67-...	67A	2297641	EAMM-A-P6-38A-67A
With integrated drive and gear unit			
EMCA-EC-67-... EMGC-40-...	40G	2297645	EAMM-A-P6-38A-40G
EGSK-46			
With servo motor			
EMME-AS-40-...	40P	1986292	EAMM-A-P8-38A-40P
Third-party motor	40A	562652	EAMM-A-P8-38A-40A
Third-party motor	55A	562653	EAMM-A-P8-38A-55A
Third-party motor	58AA	8105910	EAMM-A-P8-38A-58AA
EMMT-AS-60-..., EMME-AS-60-..., third-party motor	60P	1987308	EAMM-A-P8-38A-60P
Third-party motor	60R	8105916	EAMM-A-P8-38A-60R
Third-party motor	60RA	8105914	EAMM-A-P8-38A-60RA
Third-party motor	70A	564996	EAMM-A-P8-38A-70A
Third-party motor	70AA, 70AB	8105920	EAMM-A-P8-38A-70AA
With servo motor and gear unit			
EMME-AS-40-... EMGA-40-P-G...-EAS-40	40G	2297646	EAMM-A-P8-38A-40G
With stepper motor			
EMMS-ST-42-..., third-party motor	42A	562650	EAMM-A-P8-38A-42A
EMMS-ST-57-... Third-party motor	57A	562651	EAMM-A-P8-38A-57A
EMMS-ST-87-...	60AA	8105913	EAMM-A-P8-38A-60AA
EMMS-ST-87-...	87A	564998	EAMM-A-P8-38A-87A
With stepper motor and gear unit			
EMMS-ST-42-... EMGA-40-P-G...-SST-42	40G	2297646	EAMM-A-P8-38A-40G
With integrated drive			
EMCA-EC-67-...	67A	2297643	EAMM-A-P8-38A-67A
With integrated drive and gear unit			
EMCA-EC-67-... EMGC-40-...	40G	2297646	EAMM-A-P8-38A-40G

1) The input torque must not exceed the max. permissible transferable torque of the axial kit.

Product range overview

Permissible axis/motor combinations with toothed belt axis ELGR, ELGG

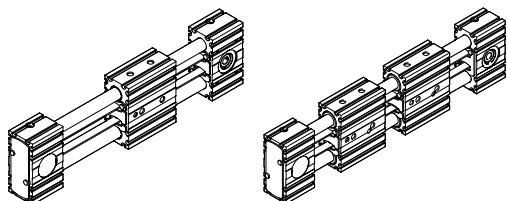

Table of interfaces for third-party motors

→ from page 58

Technical data for axial kits

→ from page 62

Motor/gear unit ¹⁾ Type	Motor interface	Axial kit	
		Part no.	Type
ELGR-35, ELGG-35			
With servo motor			
Third-party motor	55A	1133400	EAMM-A-R27-55A
With servo motor and gear unit			
EMME-AS-40-... EMGA-40-P-G...-EAS-40	40G	1456622	EAMM-A-R27-40G
With servo motor and angled gear unit			
EMME-AS-40-... EMGA-40-A-G...-40P	40G	1456622	EAMM-A-R27-40G
With stepper motor			
EMMS-ST-57-...	57A	★ 1133403	EAMM-A-R27-57A
With stepper motor and gear unit			
EMMS-ST-42-... EMGA-40-P-G...-SST-42	40G	1456622	EAMM-A-R27-40G
With integrated drive			
EMCA-EC-67-...	67A	1456619	EAMM-A-R27-67A
With integrated drive and gear unit			
EMCA-EC-67-... EMGC-40-...	40G	1456622	EAMM-A-R27-40G
ELGR-45, ELGG-45			
With servo motor			
EMMT-AS-60-..., EMME-AS-60-..., third-party motor	60P	★ 2224996	EAMM-A-R38-60P
Third-party motor	70A	1133401	EAMM-A-R38-70A
With servo motor and gear unit			
EMME-AS-40-... EMGA-40-P-G...-EAS-40	40G	1456623	EAMM-A-R38-40G
EMMT-AS-60-... EMGA-60-P-G...-EAS-60	60H	1456630	EAMM-A-R38-60H
EMME-AS-60-... EMGA-60-P-G...-EAS-60	60H	1456630	EAMM-A-R38-60H
With servo motor and angled gear unit			
EMME-AS-40-... EMGA-40-A-G...-40P	40G	1456623	EAMM-A-R38-40G
EMMT-AS-60-... EMGA-60-A-G...-60P	60H	1456630	EAMM-A-R38-60H
EMME-AS-60-... EMGA-60-A-G...-60P	60H	1456630	EAMM-A-R38-60H

Festo core product range



Generally ready for shipping ex works in 24 hours

Generally ready for shipping ex works in 5 days

Product range overview

Permissible axis/motor combinations with toothed belt axis ELGR, ELGG

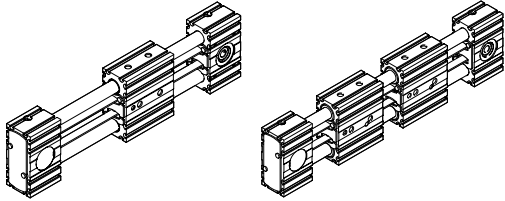

Table of interfaces for third-party motors

→ from page 58

Technical data for axial kits

→ from page 62

Motor/gear unit ¹⁾ Type	Motor interface	Axial kit	
		Part no.	Type
ELGR-45, ELGG-45			
With stepper motor			
EMMS-ST-57-...	57A	★ 1578138	EAMM-A-R38-57A
EMMS-ST-87-...	87A	★ 1133404	EAMM-A-R38-87A
With stepper motor and gear unit			
EMMS-ST-42-... EMGA-40-P-G...-SST-42	40G	1456623	EAMM-A-R38-40G
EMMS-ST-57-... EMGA-60-P-G...-SST-57	60G	2310075	EAMM-A-R38-60G
With integrated drive and gear unit			
EMCA-EC-67-... EMGC-40-...	40G	1456623	EAMM-A-R38-40G
EMCA-EC-67-... EMGC-60-...	60H	1456630	EAMM-A-R38-60H
ELGR-55, ELGG-55			
With servo motor			
Third-party motor	70A	1578139	EAMM-A-R48-70A
EMME-AS-80-..., third-party motor	80P	★ 2225090	EAMM-A-R48-80P
Third-party motor	100A	★ 1133402	EAMM-A-R48-100A
With servo motor and gear unit			
EMMT-AS-60-... EMGA-60-P-G...-EAS-60	60H	1456633	EAMM-A-R48-60H
EMME-AS-60-... EMGA-60-P-G...-EAS-60	60H	1456633	EAMM-A-R48-60H
With servo motor and angled gear unit			
EMMT-AS-60-... EMGA-60-A-G...-60P	60H	1456633	EAMM-A-R48-60H
EMME-AS-60-... EMGA-60-A-G...-60P	60H	1456633	EAMM-A-R48-60H
With stepper motor			
EMMS-ST-87-...	87A	★ 1133405	EAMM-A-R48-87A
With stepper motor and gear unit			
EMMS-ST-57-... EMGA-60-P-G...-SST-57	60G	2374780	EAMM-A-R48-60G
With integrated drive and gear unit			
EMCA-EC-67-... EMGC-60-...	60H	1456633	EAMM-A-R48-60H

1) The input torque must not exceed the max. permissible transferable torque of the axial kit.

Festo core product range



Generally ready for shipping ex works in 24 hours

Generally ready for shipping ex works in 5 days

Product range overview

Permissible axis/motor combinations with rotary module ERMB, EHMB

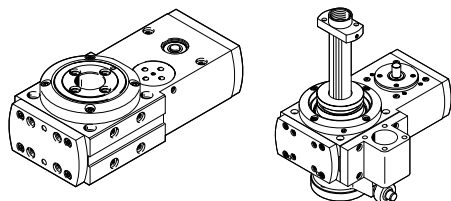

Table of interfaces for third-party motors

→ from page 58

Technical data for axial kits

→ from page 62

Motor/gear unit ¹⁾ Type	Motor interface	Axial kit	
		Part no.	Type
ERMB-20, EHMB-20			
With servo motor			
EMME-AS-40-...	40P	2207441	EAMM-A-D32-35A-40P
Third-party motor	40A	560281	EAMM-A-D32-35A-40A
Third-party motor	40R	8105826	EAMM-A-D32-40R
Third-party motor	40RA	8125610	EAMM-A-D32-40RA
Third-party motor	55A	550979	EAMM-A-D32-55A
Third-party motor	58AA	8105884	EAMM-A-D32-58AA
EMMT-AS-60-..., EMME-AS-60-..., third-party motor	60P	★ 1956054	EAMM-A-D32-60P
Third-party motor	60R	8105918	EAMM-A-D32-60R
Third-party motor	60RA	8105889	EAMM-A-D32-60RA
With servo motor and gear unit			
EMME-AS-40-... EMGA-40-P-G...-EAS-40	40G	1454238	EAMM-A-D32-40G
EMMT-AS-60-... EMGA-60-P-G...-EAS-60	60H	2946760	EAMM-A-D32-60H
EMME-AS-60-... EMGA-60-P-G...-EAS-60	60H	2946760	EAMM-A-D32-60H
With stepper motor			
EMMS-ST-42-..., third-party motor	42A	★ 543148	EAMM-A-D32-42A
EMMS-ST-57-...	57A	★ 550980	EAMM-A-D32-57A
Third-party motor	60AA	8105887	EAMM-A-D32-60AA
With stepper motor and gear unit			
EMMS-ST-42-... EMGA-40-P-G...-SST-42	40G	1454238	EAMM-A-D32-40G
EMMS-ST-57-... EMGA-60-P-G...-SST-57	60G	2946758	EAMM-A-D32-60G
With integrated drive			
EMCA-EC-67-...	67A	1454239	EAMM-A-D32-67A
With integrated drive and gear unit			
EMCA-EC-67-... EMGC-40-...	40G	1454238	EAMM-A-D32-40G
EMCA-EC-67-... EMGC-60-...	60H	2946760	EAMM-A-D32-60H
With third-party gear unit			
Third-party gear unit	50GA	8117072	EAMM-A-D32-50GA

1) The input torque must not exceed the max. permissible transferable torque of the axial kit.

Festo core product range



Generally ready for shipping ex works in 24 hours

Generally ready for shipping ex works in 5 days

Product range overview

Permissible axis/motor combinations with rotary module ERMB, EHMB

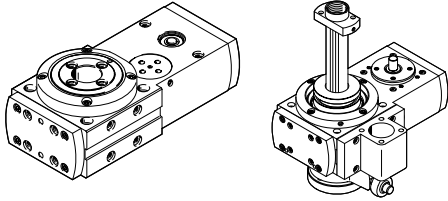

Table of interfaces for third-party motors

→ from page 58

Technical data for axial kits

→ from page 62

Motor/gear unit ¹⁾ Type	Motor interface	Axial kit	
		Part no.	Type
ERMB-25, EHMB-25			
With servo motor			
Third-party motor	55A	543153	EAMM-A-D40-55A
Third-party motor	58AA	8105928	EAMM-A-D40-58AA
EMMT-AS-60-..., EMME-AS-60-..., third-party motor	60P	★ 1977000	EAMM-A-D40-60P
Third-party motor	60R	8117079	EAMM-A-D40-60R
Third-party motor	60RA	8117078	EAMM-A-D40-60RA
Third-party motor	70A	550981	EAMM-A-D40-70A
Third-party motor	70AA, 70AB	8105952	EAMM-A-D40-70AA
With servo motor and gear unit			
EMME-AS-40-... EMGA-40-P-G-...-EAS-40	40G	★ 560282 2256398	EAMM-A-D40-40G EAMM-A-D40-40G-G2 ²⁾
EMMT-AS-60-... EMGA-60-P-G-...-EAS-60	60H	1454242	EAMM-A-D40-60H
EMME-AS-60-... EMGA-60-P-G-...-EAS-60	60H	1454242	EAMM-A-D40-60H
With stepper motor			
EMMS-ST-57-...	57A	★ 543154	EAMM-A-D40-57A
Third-party motor	60AA	8105929	EAMM-A-D40-60AA
EMMS-ST-87-...	87A	★ 550982	EAMM-A-D40-87A
With stepper motor and gear unit			
EMMS-ST-42-... EMGA-40-P-G-...-SST-42	40G	★ 560282	EAMM-A-D40-40G
EMMS-ST-57-... EMGA-60-P-G-...-SST-57	60G	2256400	EAMM-A-D40-60G
With integrated drive			
EMCA-EC-67-...	67A	1454243	EAMM-A-D40-67A
With integrated drive and gear unit			
EMCA-EC-67-... EMGC-40-...	40G	★ 560282 2256398	EAMM-A-D40-40G EAMM-A-D40-40G-G2 ²⁾
EMCA-EC-67-... EMGC-60-...	60H	1454242	EAMM-A-D40-60H
With third-party gear unit			
Third-party gear unit	50GA	8117076	EAMM-A-D40-50GA

- 1) The input torque must not exceed the max. permissible transferable torque of the axial kit.
 2) The axial kit can be retrofitted from IP40 to IP65 with the help of a seal set EADS-F → page 1.

Festo core product range



Generally ready for shipping ex works in 24 hours

Generally ready for shipping ex works in 5 days

Product range overview

Permissible axis/motor combinations with rotary module ERMB, EHMB

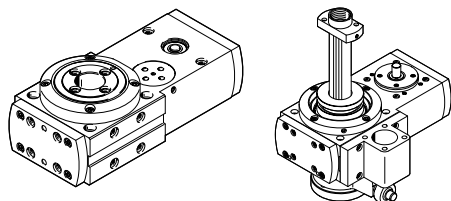

Table of interfaces for third-party motors

→ from page 58

Technical data for axial kits

→ from page 62

Motor/gear unit ¹⁾ Type	Motor interface	Axial kit	
		Part no.	Type
ERMB-32, EHMB-32			
With servo motor			
Third-party motor	70A	543161	EAMM-A-D60-70A
EMME-AS-80-..., third-party motor	80P	★ 1977073	EAMM-A-D60-80P
Third-party motor	80PB, 80R	8105937	EAMM-A-D60-80PB
Third-party motor	84AA	8105945	EAMM-A-D60-84AA
EMME-AS-100-..., third-party motor	100A	★ 550983	EAMM-A-D60-100A
With servo motor and gear unit			
EMMT-AS-60-... EMGA-60-P-G...-EAS-60	60H	1454245	EAMM-A-D60-60H
EMME-AS-60-... EMGA-60-P-G...-EAS-60	60H	1454245	EAMM-A-D60-60H
EMME-AS-80-... EMGA-80-P-G...-EAS-80	80G	1499402	EAMM-A-D60-80G
EMME-AS-100-... EMGA-80-P-G...-SAS-100	80G	1499402	EAMM-A-D60-80G
With stepper motor			
EMMS-ST-87-...	87A	★ 543162	EAMM-A-D60-87A
With stepper motor and gear unit			
EMMS-ST-57-... EMGA-60-P-G...-SST-57	60G	★ 560283 2256696	EAMM-A-D60-60G EAMM-A-D60-60G-G2 ²⁾
EMMS-ST-87-... EMGA-80-P-G...-SST-87	80G	1499402	EAMM-A-D60-80G
With integrated drive and gear unit			
EMCA-EC-67-... EMGC-60-...	60H	1454245	EAMM-A-D60-60H
With third-party gear unit			
Third-party gear unit	90GA	8105944	EAMM-A-D60-90GA

1) The input torque must not exceed the max. permissible transferable torque of the axial kit.

2) The axial kit can be retrofitted from IP40 to IP65 with the help of a seal set EADS-F → page 1.

Festo core product range



Generally ready for shipping ex works in 24 hours

Generally ready for shipping ex works in 5 days

Product range overview

Third-party motors and gear units			
Manufacturer	Type	Motor interface	
Fastech	EzM2-28	28AA	
Moons	MS11HS		
Oriental Motor	AR2x, AZ2x, CVK22		
Sanyo Denki	SH22xx		
Fastech	EzM2-35	35A	
Fulling	35 SH		
Minebea	14PY-Z		
Sanyo Denki	SH35xx		
Bosch Rexroth	MSM019A; MSM019B	38AA	
Panasonic	MSMD012J1, MSMF012, MSMF5A		
Schneider Electric	BMH 1403	40A	
Apex Dynamics INC.	PG040	40G	
B+R Automation	8GP30-040		
Bosch Rexroth	GTE040		
Neugart	PLE 040, WPLE 40		
Wittenstein Alpha	CP 005, CPK 005		
Allen-Bradley/Rockwell Automation	TL-A1x, TLY-A1x		40R
B+R Automation	8LVA1		
Beckhoff	AM301x, AM311x, AM811x, AM801x		
Inovance	ISMH1-10B30		
Kollmorgen	AKM1xx-Ax		
Mitsubishi	HF-KE13, HF-KP053, HF-KP13, HF-MP053, HF-MP13, HG-MR13B		
Omron	R7M-A10030, R88M-x05030, R88M-x10030, SGMAV-01A, SGMVA-A5A, SGMVA-C2A, SGMJV-01A, SGMJV-05A		
Sanyo Denki	R2EA04008, R2xA04005		
Siemens	1FK2102-0AG..., 1FK2102-1AG...,		
YASKAWA	SGM7J-A5A.A2., SGM7J-01A.A2., SGM7J-C2A.A2., SGM7JA-A5A.A2., SGM7JA-01A.A2., SGM7JA-C2A.A2.		
Siemens	1FK701x	40RA	
Beckhoff	AS1010, AS1020	42A	
Fastech	EzM2-42		
Minebea	17PY-Z (IP20)		
Moons	MS17HA (IP20)		
Nanotec	ST4209		
Schneider Electric	ILP2R42x		
Oriental Motor	AR4x, AZ4x		
Apex Dynamics INC.	PE 050		
Neugart	PLPE 50, WPLPE 50		
Wittenstein Alpha	NP 005, NPK 005, LP+ 050, LPK+ 050, LK+ 050		
Allen-Bradley/Rockwell Automation	MPL-x15, VPL-x063x	55A	
AMK	DT3		
B+R Automation	8LSA2		
Baumüller	DSD2-028		
Beckhoff	AM227LL, AM227M, AM802x, AM812x		
Schneider Electric	BMH 055, BSH 055		
Siemens	1FK7022, 1FT6021, 1FT6024		
SEW Eurodrive	PSF 121, PSF 122, PSKF 121, PSKF 122		
Fastech	EzM2-56		56GA
Minebea	23KY-K (IP20)		
Moons	MS23HA (IP20)		
Oriental Motor	PKP26		
B+R Automation	80MPF	57A	
Nanotec	ST6018		
Schneider Electric	BRS 364, BRS 366, IFS 61, IFS 62, ILS1x571, ILS1x572	57AB	
Schneider Electric	BRS 368; IFS 63; ILS1x573	57AC	

Product range overview

Third-party motors and gear units			
Manufacturer	Type	Motor interface	
B+R Automation	8JSA2	58AA	
Beckhoff	AM302x		
Bosch Rexroth	MSK030		
Kollmorgen	AKM2xx-Ax		
SEW Eurodrive	CMP40		
Fastech	EzM2-60	60AA	
Oriental Motor	AR6x, AZ6x	60AB	
Apex Dynamics INC.	PG060	60H	
B+R Automation	8GP30-060, 8GP40-060		
Bosch Rexroth	GTE060		
Neugart	PLE 060, WPLE 60		
Wittenstein Alpha	CP 015, CPK 015		
Bosch Rexroth	MSM 031	60P	
Omron	R88M-x40030		
Panasonic	MSMF042		
B+R Automation	8LVA2	60PA	
Inovance	ISMH1-20B30, ISMH1-40B30		
Mitsubishi	HF-KP23, HF-KP43, HK-KT23W, HK-KT43W, HF-KE23, HF-KE43, HF-MP23, HF-MP43, HG-KR43		
YASKAWA	SGM7J-02A, SGM7J-04A		
Moons	SM601AE4, SM602AE4		
Omron	SGMAH-02, SGMAM-02A, SGMAM-04A, SGMAM-06A, SGMJV-02A, SGMJV-04A		
Sanyo Denki	R2AA06040, R2AA06040FX, R2xA06020		
Siemens	1FK2xx3-...-0...		
Siemens	1FL603x-2AF21		
Tamagawa	TS4607, TS4609, TS4610		
YASKAWA	SGM7J-02A.A2., SGM7J-04A.A2., SGM7J-06A.A2.		
Allen-Bradley/Rockwell Automation	TL-A2x, TLY-A2x		60R
Bosch Rexroth	MSM030, MSM031		60RA
Omron	R88M-x20030		
Panasonic	MSMF022		
Beckhoff	AM312x	60RB	
Siemens	1FK2xx3-...-2...	68GA	
Bosch Rexroth	GTM060		
Lenze	GPA00, MPR050-1S GCN		
Neugart	PLN 70, WPLN 70		
SEW Eurodrive	PSx 221, PSx 222		
Siemens	SP 060S		
Wittenstein Alpha	SK+ 060, SP+ 060, SPC+ 060		
Allen-Bradley/Rockwell Automation	MPL-x2, VPL-x075x	70A	
AMK	DT4		
Baumüller	DSD2-036		
Lenze	MCS 06, MDSKxx036		
Schneider Electric	BMH 0701, BMH 0702, BSH 0701, BSH 0702		
SEW Eurodrive	CMP50	70AA	
B+R Automation	8JSA3		
Beckhoff	AM303x, AM803x, AM813x, AM853x		
Kollmorgen	AKM3xx-Ax		
Schneider Electric	BMH 0703, BSH 0703		
Siemens	1FT6031, 1FT6034, 1FT7034, 1FK7032, 1FK7033, 1FK7034	70AB	
Siemens	6SN2155...		
Apex Dynamics INC.	PE 070	70GA	
Neugart	PLPE 70, WPLPE 70		
SEW Eurodrive	PSCZ 221, PSCZ 222, PSKCZ 221, PSKCZ 222		
Wittenstein Alpha	NP 015, NPK 015, LP+ 070, LPK+ 070, LK+ 070		

Product range overview

Third-party motors and gear units		
Manufacturer	Type	Motor interface
B+R Automation	8GP60-070	72GA
Neugart	PLN 70 (OP14), WPLN 70 (OP14)	
Bosch Rexroth	GTM075	75GA
Lenze	GPA01	
Neugart	PLN 90, WPLN 90	
SEW Eurodrive	PSC 321, PSC 322, PSF 321, PSF 322, PSKC 321, PSKC 322, PSKF 321, PSKF 322	
Siemens	SP 075S	
Wittenstein Alpha	SK+ 075, SP+ 075, SPK+ 075, SPC+ 075	
Apex Dynamics INC.	PG080	80G
B+R Automation	8GP40-080	
Bosch Rexroth	GTE080	
Neugart	PLE 080, WPLE 80	
Schneider Electric	GBX080	
Wittenstein Alpha	CP 025, CPK 025	
Bosch Rexroth	MSM040, MSM041	80P
Omron	R88M-x75030	
Panasonic	MSMF082	
B+R Automation	8LVA3	80PA
Inovance	ISMH1-75B30	
Mitsubishi	HG-KR73, HK-KT7M3W	
Moons	SM803AE4	
Siemens	1FK2104-4AK..., 1FK2104-5AK...	
YASKAWA	SGM7J-08A.A2.	
Sanyo Denki	R2AA08075	80PB
Bosch Rexroth	MSK040, MK043	82AA
B+R Automation	8JSA4	84AA
Beckhoff	AM304xt, AM354x, AM804x, AM814x	
Kollmorgen	AKM4xx-Ax	
Siemens	1FK7040, 1FK7042, 1FK7043, 1FK7044, 1FT6041, 1FT6044, 1FT704x	
Oriental Motor	AR9x, AZ9x	
B+R Automation	8LSA3	85AA
Baumüller	DSC1-045, DSD2-045	
Beckhoff	AM247L	
Lenze	MCA 10 FF100, MCS 09, MDSKSxx056 FF100	
SEW Eurodrive	CMP63	
Apex Dynamics INC.	PE 090	
Neugart	PLPE 90, WPLPE 90	88A
Wittenstein Alpha	NP 025, NPK 025, LP+ 090, LPK+ 090, LK+ 090	
Allen-Bradley/Rockwell Automation	TLY-A3x	90R
Sanyo Denki	R2AAB8100	
Allen-Bradley/Rockwell Automation	MPF-x3, VPL-x100x	92RA
SEW Eurodrive	WF10 Ø120, WF10DT56	
Allen-Bradley/Rockwell Automation	MPL-x4, VPL-x115x	100A
AMK	DT5, DTK5	
B+R Automation	8LSA4	
Beckhoff	AM257S, AM257M	
Bosch Rexroth	MSK050	
SEW Eurodrive	CFM71	
Allen-Bradley/Rockwell Automation	MPL-x45, VPL-x130x	108AA
Beckhoff	AM305x, AM355x	
Kollmorgen	AKM5xx-Ax	

Product range overview

Third-party motors and gear units		
Manufacturer	Type	Motor interface
Bosch Rexroth	GTM100	115GA
Lenze	GPA02	
Neugart	PLN 115, WPLN 115	
SEW Eurodrive	PSC 521, PSC 522, PSF 521, PSF 522, PSKC 521, PSKC 522, PSKF 521, PSKF 522	
Siemens	SP 100S	
Wittenstein Alpha	SK+ 100, SP+ 100, SPK+ 100, SPC+ 100	
Apex Dynamics INC.	PG120	120G
Bosch Rexroth	GTE120	
Neugart	PLE 120, WPLE 120	
Schneider Electric	GBX120	120GA
Wittenstein Alpha	CP 035, CPK 035	
Apex Dynamics INC.	PG080A	
Lenze	GKR03-2M VAK, GKR04-2S VAK	
Neugart	PLE 080-90, WPLE 80-90	
SEW Eurodrive	RF07 Ø120, SF37 Ø120, WF30 Ø120, WF37 Ø120	120GB
Siemens	BF29-KQ-703	
SEW Eurodrive	RF27 Ø120	120GC
Siemens	ZF29-KQ-704, ZF29-KQ-706	
Apex Dynamics INC.	PE 120	126AA
Neugart	PLPE 120, WPLPE 120	
Wittenstein Alpha	NP 035, NPK 035, LP+ 120, LPK+ 120, LK+ 120	
Baumüller	DSC1-056, DSD2-056	160G
SEW Eurodrive	CMPZ71	
Siemens	1FK7060, 1FK7062, 1FK7063, 1FT6061, 1FT6062, 1FT6064, 1FT7062, 1FT7064, 1FT7066, 1FT7068	
Apex Dynamics INC.	PG160	190A
Bosch Rexroth	GTE160	
Neugart	PLE 160	
SEW Eurodrive	CFM112	

Data sheet

Material:

Coupling housing, coupling hubs,

motor flange: Aluminium

Screws: Galvanised steel

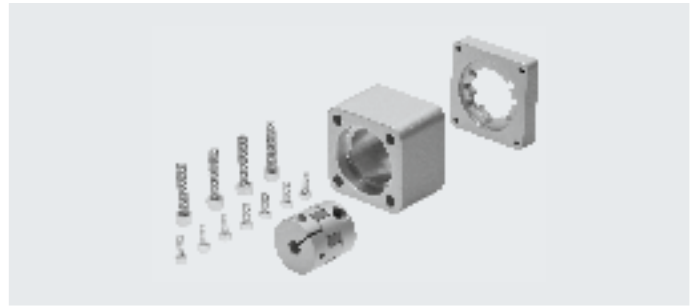

General technical data						
Type	For axis	Transferable torque [Nm]	Mass moment of inertia [kgmm ²]	Max. rotational speed [rpm]	Weight [g]	→ Page
EAMM-A-D19-28A	EGSL	1.1	0.28	10000	80	72
EAMM-A-D19-38AA	EGSL	1.1	0.28	10000	121	
EAMM-A-D19-40A	EGSL	1.1	0.28	10000	110	
EAMM-A-D19-40P	EGSL	1.1	0.28	10000	110	
EAMM-A-D19-40R	EGSL	1.1	0.28	10000	133	
EAMM-A-D19-42A	EGSL	1.1	0.28	10000	130	
EAMM-A-D32-40A	EGSL, ESBF	1.1	0.28	10000	130	
EAMM-A-D32-40G	EGSL, EHMB, ERMB, ESBF	6.5	5.87	8000	420	
EAMM-A-D32-40P	EGSL, ESBF	1.1	0.28	10000	160	
EAMM-A-D32-40R	EGSL, ESBF	6.5	5.87	8000	309	
EAMM-A-D32-40RA	EGSL, ESBF	6.5	5.87	8000	309	
EAMM-A-D32-35A-40A	EHMB, ERMB	4	5.87	8000	220	
EAMM-A-D32-35A-40P	EHMB, ERMB	4	5.87	8000	160	
EAMM-A-D32-42A	EGSL, EHMB, ERMB, ESBF	1.1	0.28	10000	140	
EAMM-A-D32-50GA	EGSL, EHMB, ERMB, ESBF	6.5	5.87	8000	446	
EAMM-A-D32-55A	EGSL, EHMB, ERMB, ESBF	4	5.87	8000	260	
EAMM-A-D32-58AA	EGSL, EHMB, ERMB, ESBF	6.5	5.87	8000	329	
EAMM-A-D32-60AA	EGSL, EHMB, ERMB, ESBF	6.5	5.87	8000	341	
EAMM-A-D32-57A	EGSL, EHMB, ERMB, ESBF	4	5.87	8000	270	
EAMM-A-D32-60G	EGSL, EHMB, ERMB, ESBF	6.5	5.87	8000	540	
EAMM-A-D32-60H	EGSL, EHMB, ERMB, ESBF	6.5	5.87	8000	540	
EAMM-A-D32-60P	EGSL, EHMB, ERMB, ESBF	4	5.87	8000	410	
EAMM-A-D32-60R	EGSL, EHMB, ERMB, ESBF	6.5	5.87	8000	386	
EAMM-A-D32-60RA	EGSL, EHMB, ERMB, ESBF	6.5	5.87	8000	420	
EAMM-A-D32-67A	EGSL, ESBF	6.5	5.87	8000	410	
EAMM-A-D40-40G	EGSL, EHMB, ERMB	8	5.87	8000	350	
EAMM-A-D40-40G-G2	EGSL, EHMB, ERMB, ESBF	8	5.87	8000	450	
EAMM-A-D40-50GA	EGSL, EHMB, ERMB, ESBF	12.5	5.87	8000	438	
EAMM-A-D40-55A	EGSL, EHMB, ERMB, ESBF	8	5.87	8000	350	
EAMM-A-D40-57A	EGSL, EHMB, ERMB, ESBF	6	5.87	8000	350	
EAMM-A-D40-58AA	EGSL, EHMB, ERMB, ESBF	12.5	5.87	8000	354	
EAMM-A-D40-60AA	EGSL, EHMB, ERMB, ESBF	12.5	5.87	8000	363	
EAMM-A-D40-60G	EGSL, EHMB, ERMB, ESBF	12.5	5.87	8000	570	
EAMM-A-D40-60H	EGSL, EHMB, ERMB, ESBF	12.5	5.87	8000	570	
EAMM-A-D40-60P	EGSL, EHMB, ERMB, ESBF	8	5.87	8000	430	
EAMM-A-D40-60R	EGSL, EHMB, ERMB, ESBF	12.5	5.87	8000	368	
EAMM-A-D40-60RA	EGSL, EHMB, ERMB, ESBF	12.5	5.87	8000	336	
EAMM-A-D40-67A	EGSL, EHMB, ERMB, ESBF	12.5	5.87	8000	440	
EAMM-A-D40-70AA	EGSL, EHMB, ERMB, ESBF	12.5	5.87	8000	443	
EAMM-A-D40-70A	EGSL, EHMB, ERMB, ESBF	8	5.87	8000	410	
EAMM-A-D40-87A	EGSL, EHMB, ERMB, ESBF	8	5.87	8000	530	

Data sheet

General technical data							
Type	For axis	Transferable torque [Nm]	Mass moment of inertia [kgmm ²]	Max. rotational speed [rpm]	Weight [g]	→ Page	
EAMM-A-D50-60G	ESBF	17	34.8	6000	570	72	
EAMM-A-D50-60H	ESBF	17	34.8	6000	570		
EAMM-A-D50-70A	ESBF	12	34.8	6000	740		
EAMM-A-D50-70GA	ESBF	17	34.8	6000	1018		
EAMM-A-D50-80G	ESBF	17	34.8	6000	1190		
EAMM-A-D50-80P	ESBF	14	34.8	6000	890		
EAMM-A-D50-80PB	ESBF	17	34.8	6000	892		
EAMM-A-D50-82AA	ESBF	17	34.8	6000	815		
EAMM-A-D50-84AA	ESBF	17	34.8	6000	1012		
EAMM-A-D50-87A	ESBF	12	34.8	6000	860		
EAMM-A-D50-100A	ESBF	14	34.8	6000	1140		
EAMM-A-D60-60G	EGSL, EHMB, ERMB,	12	34.8	6000	830		
EAMM-A-D60-60G-G2	EGSL, EHMB, ERMB, ESBF	12	34.8	6000	1350		
EAMM-A-D60-60H	EGSL, EHMB, ERMB, ESBF	17	34.8	6000	1250		
EAMM-A-D60-70A	EGSL, EHMB, ERMB, ESBF	12	34.8	6000	750		
EAMM-A-D60-80G	EGSL, EHMB, ERMB, ESBF	17	34.8	6000	1350		
EAMM-A-D60-80P	EGSL, EHMB, ERMB, ESBF	14	34.8	6000	1040		
EAMM-A-D60-80PB	EGSL, EHMB, ERMB, ESBF	21	34.8	6000	1041		
EAMM-A-D60-84AA	EGSL, EHMB, ERMB, ESBF	21	34.8	6000	1173		
EAMM-A-D60-87A	EGSL, EHMB, ERMB, ESBF	12	34.8	6000	890		
EAMM-A-D60-90GA	EGSL, EHMB, ERMB, ESBF	21	34.8	6000	2192		
EAMM-A-D60-100A	EGSL, EHMB, ERMB, ESBF	14	34.8	6000	1170		
EAMM-A-D80-80G	ESBF	60	128	5500	1990		
EAMM-A-D80-84AA	ESBF	60	128	5500	1843		
EAMM-A-D80-90GA	ESBF	60	128	550	2192		
EAMM-A-D80-100A	ESBF	60	128	5500	2030		
EAMM-A-D80-140A	ESBF	60	128	5500	2920		
EAMM-A-D100-100A	ESBF	60	128	5500	2450		
EAMM-A-D100-120G	ESBF	143	280	4500	3520		
EAMM-A-D100-140A	ESBF	143	280	4500	3460		
EAMM-A-L27-40G	EGC-TB	2	0.445	10000	180		82
EAMM-A-L27-55A	EGC-TB	2	0.445	10000	220		
EAMM-A-L27-57A	EGC-TB	1.6	0.355	10000	180		
EAMM-A-L27-67A	EGC-TB	2	0.445	10000	290		
EAMM-A-L27-40A	EGC-TB	1.5	0.355	10000	82		
EAMM-A-L27-40R	EGC-TB	1.6	0.355	10000	110		
EAMM-A-L27-40RA	EGC-TB	1.6	0.355	10000	84		
EAMM-A-L27-42A	EGC-TB	1.2	0.45	10000	157		
EAMM-A-L27-58AA	EGC-TB	2	0.355	10000	165		
EAMM-A-L27-57AA	EGC-TB	1.6	0.355	10000	184		
EAMM-A-L27-57AB	EGC-TB	1.6	0.355	10000	184		
EAMM-A-L27-57AC	EGC-TB	1.6	0.45	10000	183		
EAMM-A-L27-60RA	EGC-TB	2	0.45	10000	278		
EAMM-A-L27-60RB	EGC-TB	2	0.45	10000	221		
EAMM-A-L27-50GA	EGC-TB	2	0.45	10000	197		
EAMM-A-L27-60G	EGC-TB	2	0.45	10000	307		
EAMM-A-L38-55A	EGC-TB	4.4	0.445	8000	210		
EAMM-A-L38-57A	EGC-TB	3.6	3.2	8000	220		
EAMM-A-L38-60AA	EGC-TB	8	3.2	8000	231		
EAMM-A-L38-60G	EGC-TB	4.4	3.2	8000	350		
EAMM-A-L38-60H	EGC-TB	4.4	3.3	8000	340		
EAMM-A-L38-60P	EGC-TB	4.4	3.3	8000	300		
EAMM-A-L38-60R	EGC-TB	9	3.2	8000	298		
EAMM-A-L38-70A	EGC-TB	4.4	3.2	8000	290		
EAMM-A-L38-87A	EGC-TB	4.4	3.2	8000	480		
EAMM-A-L38-58AA	EGC-TB	9	3.2	8000	208		

Data sheet

General technical data						
Type	For axis	Transferable torque [Nm]	Mass moment of inertia [kgmm ²]	Max. rotational speed [rpm]	Weight [g]	→ Page
EAMM-A-L38-57AA	EGC-TB	8	3.2	8000	221	82
EAMM-A-L38-60PA	EGC-TB	9	3.3	8000	301	
EAMM-A-L38-60RB	EGC-TB	9	3.2	8000	253	
EAMM-A-L38-70AA	EGC-TB	9	3.3	8000	357	
EAMM-A-L38-88A	EGC-TB	9	3.3	8000	508	
EAMM-A-L38-84AA	EGC-TB	9	4.6	8000	712	
EAMM-A-L38-40G	EGC-TB	9	3.2	8000	259	
EAMM-A-L38-50GA	EGC-TB	9	3.2	8000	245	
EAMM-A-L38-56GA	EGC-TB	9	3.3	8000	275	
EAMM-A-L38-70GA	EGC-TB	9	4	8000	457	
EAMM-A-L38-67GA	EGC-TB	9	4	8000	363	
EAMM-A-L38-72GA	EGC-TB	9	4	8000	480	
EAMM-A-L48-60G	EGC-TB	12.5	14.5	8000	490	
EAMM-A-L48-60H	EGC-TB	12.5	14.5	8000	430	
EAMM-A-L48-70A	EGC-TB	12.5	14.5	8000	350	
EAMM-A-L48-80P	EGC-TB	17	39	6000	660	
EAMM-A-L48-87A	EGC-TB	12.5	14.5	8000	590	
EAMM-A-L48-100A	EGC-TB	17	39	6000	990	
EAMM-A-L48-55A	EGC-TB	12.5	14.5	8000	352	
EAMM-A-L48-60PA	EGC-TB	12.5	14.5	8000	454	
EAMM-A-L48-70AA	EGC-TB	12.5	14.5	8000	498	
EAMM-A-L48-80PB	EGC-TB	17	39	8000	560	
EAMM-A-L48-82AA	EGC-TB	12.5	14.5	8000	613	
EAMM-A-L48-88A	EGC-TB	12.5	14.5	8000	639	
EAMM-A-L48-90R	EGC-TB	12.5	14.5	8000	741	
EAMM-A-L48-92RA	EGC-TB	12.5	14.5	8000	827	
EAMM-A-L48-84AA	EGC-TB	17	39	6000	925	
EAMM-A-L48-40G	EGC-TB	12.5	14.5	8000	405	
EAMM-A-L48-50GA	EGC-TB	12.5	14.5	8000	394	
EAMM-A-L48-56GA	EGC-TB	12.5	14.5	8000	430	
EAMM-A-L48-70GA	EGC-TB	12.5	14.5	8000	601	
EAMM-A-L48-75GA	EGC-TB	17	39	6000	704	
EAMM-A-L48-80G	EGC-TB	17	39	6000	798	
EAMM-A-L48-68GA	EGC-TB	12.5	14.5	8000	542	
EAMM-A-L48-72GA	EGC-TB	12.5	14.5	8000	623	
EAMM-A-L48-90GA	EGC-TB	17	39	6000	675	
EAMM-A-L48-120GA	EGC-TB	17	39	6000	656	
EAMM-A-L62-80G	EGC-TB	47	147	5500	1620	
EAMM-A-L62-100A	EGC-TB	47	147	5500	1610	
EAMM-A-L62-140A	EGC-TB	47	147	5500	2420	
EAMM-A-L62-88A	EGC-TB	38	147	5500	977	
EAMM-A-L62-84AA	EGC-TB	60	147	5500	1126	
EAMM-A-L62-108AA	EGC-TB	60	147	5500	2033	
EAMM-A-L62-56GA	EGC-TB	38	147	5500	941	
EAMM-A-L62-60H	EGC-TB	38	147	5500	914	
EAMM-A-L62-70GA	EGC-TB	48	147	5500	935	
EAMM-A-L62-75GA	EGC-TB	60	147	5500	1274	
EAMM-A-L62-68GA	EGC-TB	48	147	5500	1197	
EAMM-A-L62-72GA	EGC-TB	48	147	5500	1259	
EAMM-A-L62-90GA	EGC-TB	60	147	5500	1399	
EAMM-A-L62-115GA	EGC-TB	60	147	5500	2296	
EAMM-A-L62-120G	EGC-TB	60	147	5500	1798	
EAMM-A-L62-120GA	EGC-TB	60	147	5500	1274	
EAMM-A-L62-120GB	EGC-TB	60	147	5500	1465	
EAMM-A-L62-120GC	EGC-TB	60	147	5500	1774	
EAMM-A-L95-80G-G2	ELGA-TB	120	374	4500	2771	

Data sheet

General technical data							
Type	For axis	Transferable torque [Nm]	Mass moment of inertia [kgmm ²]	Max. rotational speed [rpm]	Weight [g]	→ Page	
EAMM-A-L95-120G-G2	ELCC-TB, ELGA-TB, EGC-TB	150	374	4500	2935	71, 89, 82	
EAMM-A-L95-140A-G2	ELCC-TB, ELGA-TB, EGC-TB	143	374	4500	3175		
EAMM-A-L95-190A-G2	ELGA-TB, EGC-TB	192	374	4500	4900	89, 82	
EAMM-A-L95-75GA	ELGA-TB, EGC-TB	133	374	4500	3087		
EAMM-A-L95-68GA	ELGA-TB, EGC-TB	93	374	4500	2867		
EAMM-A-L95-72GA	ELGA-TB, EGC-TB	93	374	4500	2867		
EAMM-A-L95-90GA	ELGA-TB, EGC-TB	133	374	4500	2793		
EAMM-A-L95-115GA	ELGA-TB, EGC-TB	192	374	4500	3633		
EAMM-A-L95-120GA	ELGA-TB, EGC-TB	120	374	4500	2635		
EAMM-A-L95-120GB	ELGA-TB, EGC-TB	150	374	4500	3113		
EAMM-A-L95-120GC	ELGA-TB, EGC-TB	192	374	4500	3662		
EAMM-A-L95-160G	ELGA-TB, EGC-TB	192	425	4500	5839		
EAMM-A-M43-60G	EGC-HD-TB	12.5	14.5	8000	340		96
EAMM-A-M43-60H	EGC-HD-TB	12.5	14.5	8000	330		
EAMM-A-M43-55A	EGC-HD-TB	12.5	14.5	8000	254		
EAMM-A-M43-70A	EGC-HD-TB	12.5	14.5	8000	358		
EAMM-A-M43-70AA	EGC-HD-TB	12.5	14.5	8000	375		
EAMM-A-M43-90R	EGC-HD-TB	12.5	14.5	8000	510		
EAMM-A-M43-92RA	EGC-HD-TB	12.5	14.5	8000	687		
EAMM-A-M43-40G	EGC-HD-TB	12.5	14.5	8000	316		
EAMM-A-M43-50GA	EGC-HD-TB	12.5	14.5	8000	296		
EAMM-A-M43-56GA	EGC-HD-TB	12.5	14.5	8000	330		
EAMM-A-M43-70GA	EGC-HD-TB	12.5	14.5	8000	531		
EAMM-A-M43-68GA	EGC-HD-TB	12.5	14.5	8000	361		
EAMM-A-M43-72GA	EGC-HD-TB	12.5	14.5	8000	462		
EAMM-A-M48-60H	EGC-HD-TB	21	39	6000	320		
EAMM-A-M48-80G	EGC-HD-TB	21	39	6000	870		
EAMM-A-M48-88A	EGC-HD-TB	21	39	6000	525		
EAMM-A-M48-84AA	EGC-HD-TB	17	39	6000	711		
EAMM-A-M48-40G	EGC-HD-TB	17	39	6000	347		
EAMM-A-M48-50GA	EGC-HD-TB	17	39	6000	342		
EAMM-A-M48-56GA	EGC-HD-TB	21	39	6000	390		
EAMM-A-M48-60G	EGC-HD-TB	17	39	6000	404		
EAMM-A-M48-70GA	EGC-HD-TB	17	39	6000	493		
EAMM-A-M48-75GA	EGC-HD-TB	17	39	6000	594		
EAMM-A-M48-68GA	EGC-HD-TB	17	39	6000	466		
EAMM-A-M48-72GA	EGC-HD-TB	17	39	6000	517		
EAMM-A-M48-90GA	EGC-HD-TB	17	39	6000	789		
EAMM-A-M48-120GA	EGC-HD-TB	17	39	6000	600		
EAMM-A-M80-120G	EGC-HD-TB	75	147	5500	1370		
EAMM-A-M80-84AA	EGC-HD-TB	60	147	5500	944		
EAMM-A-M80-75GA	EGC-HD-TB	60	147	5500	1011		
EAMM-A-M80-80G	EGC-HD-TB	60	147	5500	771		
EAMM-A-M80-68GA	EGC-HD-TB	48	147	5500	842		
EAMM-A-M80-90GA	EGC-HD-TB	60	172	5500	1177		
EAMM-A-M80-115GA	EGC-HD-TB	60	147	5500	1715		
EAMM-A-M80-120GA	EGC-HD-TB	60	192	5500	1569		
EAMM-A-M80-120GB	EGC-HD-TB	60	147	5500	1744		
EAMM-A-M80-120GC	EGC-HD-TB	60	147	5500	2115		

Data sheet

General technical data						
Type	For axis	Transferable torque [Nm]	Mass moment of inertia [kgmm ²]	Max. rotational speed [rpm]	Weight [g]	→ Page
EAMM-A-N38-60G	ELGA-TB	12.5	14.5	8000	470	89
EAMM-A-N38-60H	ELGA-TB	12.5	14.5	8000	460	
EAMM-A-N38-70A	ELGA-TB	12.5	14.5	8000	430	
EAMM-A-N38-87A	ELGA-TB	12.5	14.5	8000	646	
EAMM-A-N38-60PA	ELGA-TB	12.5	14.5	8000	439	
EAMM-A-N38-60RA	ELGA-TB	12.5	14.5	8000	396	
EAMM-A-N38-70AA	ELGA-TB	12.5	14.5	8000	461	
EAMM-A-N38-88A	ELGA-TB	12.5	14.5	8000	594	
EAMM-A-N38-90R	ELGA-TB	12.5	14.5	8000	716	
EAMM-A-N38-92RA	ELGA-TB	12.5	14.5	8000	810	
EAMM-A-N38-40G	ELGA-TB	12.5	14.5	8000	411	
EAMM-A-N38-50GA	ELGA-TB	12.5	14.5	8000	392	
EAMM-A-N38-56GA	ELGA-TB	12.5	14.5	8000	414	
EAMM-A-N38-70GA	ELGA-TB	12.5	14.5	8000	712	
EAMM-A-N38-68GA	ELGA-TB	12.5	14.5	8000	454	
EAMM-A-N38-72GA	ELGA-TB	12.5	14.5	8000	605	
EAMM-A-N48-60G	ELCC-TB, ELGA-TB	12.5	14.5	8000	509	71, 89
EAMM-A-N48-60H	ELCC-TB, ELGA-TB	12.5	14.5	8000	470	
EAMM-A-N48-80G	ELCC-TB, ELGA-TB	21	39	6000	1080	
EAMM-A-N48-80P	ELCC-TB	17	39	6000	852	71
EAMM-A-N48-80PB	ELGA-TB	17	39	6000	613	89
EAMM-A-N48-100A	ELCC-TB, ELGA-TB	17	39	6000	1070	71, 89
EAMM-A-N48-60PA	ELGA-TB	21	39	6000	558	89
EAMM-A-N48-70AA	ELGA-TB	21	39	6000	592	
EAMM-A-N48-80P	ELGA-TB	17	39	6000	883	
EAMM-A-N48-80PB	ELGA-TB	17	39	6000	613	
EAMM-A-N48-88A	ELGA-TB	21	39	6000	807	
EAMM-A-N48-84AA	ELGA-TB	17	39	6000	1139	
EAMM-A-N48-50GA	ELGA-TB	17	39	6000	519	
EAMM-A-N48-56GA	ELGA-TB	21	39	6000	577	
EAMM-A-N48-70GA	ELGA-TB	17	39	6000	772	
EAMM-A-N48-75GA	ELGA-TB	17	39	6000	756	
EAMM-A-N48-68GA	ELGA-TB	17	39	6000	627	
EAMM-A-N48-72GA	ELGA-TB	17	39	6000	679	
EAMM-A-N48-90GA	ELGA-TB	17	39	6000	1279	
EAMM-A-N48-120GA	ELGA-TB	17	39	6000	1016	
EAMM-A-N80-80G	ELCC-TB, ELGA-TB	47	147	5500	1290	
EAMM-A-N80-120G	ELGA-TB	47	147	5500	1990	71
EAMM-A-N80-140A	ELCC-TB, ELGA-TB	47	147	5500	2070	71, 89
EAMM-A-N80-84AA	ELGA-TB	60	147	5500	1409	89
EAMM-A-N80-100A	ELGA-TB	60	147	5500	1461	
EAMM-A-N80-70GA	ELGA-TB	48	147	5500	1289	
EAMM-A-N80-75GA	ELGA-TB	60	147	5500	1651	
EAMM-A-N80-68GA	ELGA-TB	48	147	5500	1241	
EAMM-A-N80-72GA	ELGA-TB	48	147	5500	1289	
EAMM-A-N80-90GA	ELGA-TB	60	147	5500	1698	
EAMM-A-N80-115GA	ELGA-TB	60	147	5500	2092	
EAMM-A-N80-120GA	ELGA-TB	60	147	5500	2307	
EAMM-A-N80-120GB	ELGA-TB	60	147	5500	2143	
EAMM-A-N80-120GC	ELGA-TB	60	147	5500	2514	

Data sheet

General technical data							→ Page
Type	For axis	Transferable torque [Nm]	Mass moment of inertia [kgmm ²]	Max. rotational speed [rpm]	Weight [g]		
EAMM-A-S38-40A-G2	EGC-BS, EGC-HD-BS, ELGA-BS	6.5	5.87	8000	270	86, 98, 92	
EAMM-A-S38-40G-G2	EGC-BS, EGC-HD-BS, ELGA-BS	6.5	5.87	8000	410		
EAMM-A-S38-40P-G2	EGC-BS, EGC-HD-BS, ELGA-BS	6.5	5.87	8000	280		
EAMM-A-S38-42A-G2	EGC-BS, EGC-HD-BS, ELGA-BS	3.5	5.87	8000	310		
EAMM-A-S38-50GA	EGC-BS, EGC-HD-BS, ELGA-BS	6.5	5.87	8000	362		
EAMM-A-S38-55A-G2	EGC-BS, EGC-HD-BS, ELGA-BS	6.5	5.87	8000	340		
EAMM-A-S38-57A-G2	EGC-BS, EGC-HD-BS, ELGA-BS	6.5	5.87	8000	340		
EAMM-A-S38-58AA	EGC-BS, EGC-HD-BS, ELGA-BS	6.5	5.87	8000	339		
EAMM-A-S38-60AA	EGC-BS, EGC-HD-BS, ELGA-BS	6.5	5.87	8000	365		
EAMM-A-S38-60R	EGC-BS, EGC-HD-BS, ELGA-BS	6.5	5.87	8000	358		
EAMM-A-S38-60RA	EGC-BS, EGC-HD-BS, ELGA-BS	6.5	5.87	8000	401		
EAMM-A-S38-60P-G2	EGC-BS, EGC-HD-BS, ELGA-BS	6.5	5.87	8000	420		
EAMM-A-S38-67A-G2	EGC-BS, EGC-HD-BS, ELGA-BS	6.5	5.87	8000	492		
EAMM-A-S48-40G-G2	EGC-BS, EGC-HD-BS, ELGA-BS	12.5	5.87	8000	420		
EAMM-A-S48-50GA	EGC-BS, EGC-HD-BS, ELGA-BS	12.5	5.87	8000	406		
EAMM-A-S48-55A-G2	EGC-BS, EGC-HD-BS, ELGA-BS	12.5	5.87	8000	370		
EAMM-A-S48-57A-G2	EGC-BS, EGC-HD-BS, ELGA-BS	6.5	5.87	8000	570		
EAMM-A-S48-58AA	EGC-BS, EGC-HD-BS, ELGA-BS	12.5	5.87	8000	373		
EAMM-A-S48-60AA	EGC-BS, EGC-HD-BS, ELGA-BS	12.5	5.87	8000	415		
EAMM-A-S48-60G-G2	EGC-BS, EGC-HD-BS, ELGA-BS	12.5	5.87	8000	440		
EAMM-A-S48-60H-G2	EGC-BS, EGC-HD-BS, ELGA-BS	12.5	5.87	8000	430		
EAMM-A-S48-60P-G2	EGC-BS, EGC-HD-BS, ELGA-BS	12.5	5.87	8000	440		
EAMM-A-S48-60R	EGC-BS, EGC-HD-BS, ELGA-BS	12.5	5.87	8000	478		
EAMM-A-S48-RA	EGC-BS, EGC-HD-BS, ELGA-BS	12.5	5.87	8000	476		
EAMM-A-S48-70A-G2	EGC-BS, EGC-HD-BS, ELGA-BS	12.5	5.87	8000	450		
EAMM-A-S48-70AA	EGC-BS, EGC-HD-BS, ELGA-BS	12.5	5.87	8000	498		
EAMM-A-S48-87A-G2	EGC-BS, EGC-HD-BS, ELGA-BS	12.5	5.87	8000	590		
EAMM-A-S62-60G-G2	EGC-BS, EGC-HD-BS, ELGA-BS	21	42.3	6500	1110		
EAMM-A-S62-60H-G2	EGC-BS, EGC-HD-BS, ELGA-BS	21	42.3	6500	1100		
EAMM-A-S62-70A-G2	EGC-BS, EGC-HD-BS, ELGA-BS	17	45.5	6000	1040		
EAMM-A-S62-70GA	EGC-BS, EGC-HD-BS, ELGA-BS	17	34.8	6000	1109		
EAMM-A-S62-80G-G2	EGC-BS, EGC-HD-BS, ELGA-BS	17	34.8	6000	1180		
EAMM-A-S62-80P-G2	EGC-BS, EGC-HD-BS, ELGA-BS	17	34.8	6000	970		
EAMM-A-S62-80PB	EGC-BS, EGC-HD-BS, ELGA-BS	17	34.8	6000	978		
EAMM-A-S62-82AA	EGC-BS, EGC-HD-BS, ELGA-BS	21	34.8	6000	1050		
EAMM-A-S62-84AA	EGC-BS, EGC-HD-BS, ELGA-BS	17	34.8	6000	1037		
EAMM-A-S62-87A-G2	EGC-BS, EGC-HD-BS, ELGA-BS	17	45.5	6000	1150		
EAMM-A-S62-100A-G2	EGC-BS, EGC-HD-BS, ELGA-BS	17	34.8	6000	1240		
EAMM-A-S62-140A-G2	EGC-BS, EGC-HD-BS, ELGA-BS	17	34.8	6000	2060		
EAMM-A-S95-84AA	EGC-BS, EGC-HD-BS, ELGA-BS	60	128	5500	3063		
EAMM-A-S95-90GA	EGC-BS, EGC-HD-BS, ELGA-BS	60	128	5500	3201		
EAMM-A-S95-100A-G2	EGC-BS, EGC-HD-BS, ELGA-BS	60	128	5500	2880		
EAMM-A-S95-140A-G2	EGC-BS, EGC-HD-BS, ELGA-BS	60	128	5500	3650		
EAMM-A-P3-28D-28A	EGSK	0.2	0.28	10000	30	100	
EAMM-A-P3-28D-40P	EGSK	0.2	0.28	10000	60		
EAMM-A-P4-28B-28A	EGSK	0.7	0.28	10000	40		
EAMM-A-P4-28B-38AA	EGSK	0.7	0.28	1000	59		
EAMM-A-P4-28B-40A	EGSK	0.7	0.28	10000	50		
EAMM-A-P4-28B-40P	EGSK	0.7	0.28	10000	50		
EAMM-A-P4-28B-40R	EGSK	1.1	0.28	10000	71		
EAMM-A-P4-28B-40RA	EGSK	1.1	0.28	10000	50		
EAMM-A-P4-28B-42A	EGSK	0.7	0.28	10000	60		

Data sheet

General technical data						
Type	For axis	Transferable torque [Nm]	Mass moment of inertia [kgmm ²]	Max. rotational speed [rpm]	Weight [g]	→ Page
EAMM-A-P5-28B-28A	EGSK	1.1	0.28	10000	40	100
EAMM-A-P5-28B-38AA	EGSK	1.1	0.28	10000	59	
EAMM-A-P5-28B-40A	EGSK	1.1	0.28	10000	50	
EAMM-A-P5-28B-40P	EGSK	1.1	0.28	10000	50	
EAMM-A-P5-28B-40R	EGSK	1.1	0.28	10000	71	
EAMM-A-P5-28B-RA	EGSK	1.1	0.28	10000	49	
EAMM-A-P5-28B-42A	EGSK	1.1	0.28	10000	60	
EAMM-A-P6-38A-40A	EGSK	6.5	5.87	8000	100	
EAMM-A-P6-38A-40G	EGSK	6.5	5.87	8000	190	
EAMM-A-P6-38A-40P	EGSK	6.5	5.87	8000	110	
EAMM-A-P6-38A-42A	EGSK	3.5	5.87	8000	160	
EAMM-A-P6-38A-55A	EGSK	6.5	5.87	8000	130	
EAMM-A-P6-38A-57A	EGSK	6.5	5.87	8000	130	
EAMM-A-P6-38A-58AA	EGSK	6.5	5.87	8000	133	
EAMM-A-P6-38A-60P	EGSK	6.5	5.87	8000	210	
EAMM-A-P6-38A-60R	EGSK	6.5	5.87	8000	210	
EAMM-A-P6-38A-60RA	EGSK	6.5	5.87	8000	209	
EAMM-A-P6-38A-67A	EGSK	6.5	5.87	8000	230	
EAMM-A-P8-38A-40A	EGSK	6.5	5.87	8000	100	
EAMM-A-P8-38A-40G	EGSK	12.5	5.87	8000	190	
EAMM-A-P8-38A-40P	EGSK	12.5	5.87	8000	110	
EAMM-A-P8-38A-42A	EGSK	3.5	5.87	8000	160	
EAMM-A-P8-38A-55A	EGSK	12.5	5.87	8000	130	
EAMM-A-P8-38A-57A	EGSK	6.5	5.87	8000	130	
EAMM-A-P8-38A-58AA	EGSK	12.5	5.87	8000	185	
EAMM-A-P8-38A-60P	EGSK	12.5	5.87	8000	210	
EAMM-A-P8-38A-67A	EGSK	12.5	5.87	8000	230	
EAMM-A-P8-38A-60AA	EGSK	12.5	5.87	8000	146	
EAMM-A-P8-38A-60R	EGSK	12.5	5.87	8000	145	
EAMM-A-P8-38A-60RA	EGSK	12.5	5.87	8000	149	
EAMM-A-P8-38A-70A	EGSK	12.5	5.87	8000	200	
EAMM-A-P8-38A-87A	EGSK	12.5	5.87	8000	380	
EAMM-A-R27-40G	ELGG, ELGR	2	0.445	10000	240	103
EAMM-A-R27-55A	ELGG, ELGR	2	0.445	10000	170	
EAMM-A-R27-57A	ELGG, ELGR	1.6	0.355	10000	170	
EAMM-A-R27-67A	ELGG, ELGR	2	0.445	10000	280	
EAMM-A-R38-40G	ELGG, ELGR	9	3.2	8000	330	
EAMM-A-R38-57A	ELGG, ELGR	3.6	3.2	8000	280	
EAMM-A-R38-60P	ELGG, ELGR	4.4	3.3	8000	350	
EAMM-A-R38-60G	ELGG, ELGR	4.4	3.2	8000	390	
EAMM-A-R38-60H	ELGG, ELGR	4.4	3.3	8000	480	
EAMM-A-R38-70A	ELGG, ELGR	4.4	3.2	8000	350	
EAMM-A-R38-87A	ELGG, ELGR	4.4	3.2	8000	530	
EAMM-A-R48-60G	ELGG, ELGR	12.5	14.5	8000	480	
EAMM-A-R48-60H	ELGG, ELGR	12.5	14.5	8000	480	
EAMM-A-R48-70A	ELGG, ELGR	12.5	14.5	8000	450	
EAMM-A-R48-80P	ELGG, ELGR	17	39	6000	710	
EAMM-A-R48-87A	ELGG, ELGR	12.5	14.5	8000	590	
EAMM-A-R48-100A	ELGG, ELGR	17	39	6000	970	

Data sheet

General technical data						
Type	For axis	Transferable torque [Nm]	Mass moment of inertia [kgmm ²]	Max. rotational speed [rpm]	Weight [g]	→ Page
EAMM-A-T42-55A	EGSC, ELGC-BS, ELGC-TB	8.5	3.2	8000	328	94
EAMM-A-T42-57A	EPCC, EGSC, ELGC-BS, ELGC-TB	6.0	3.2	8000	330	
EAMM-A-T42-58AA	EGSC, ELGC-BS, ELGC-TB	8.5	3.2	8000	310	
EAMM-A-T42-60AA	EPCC, EGSC, ELGC-BS, ELGC-TB	7.5	3.2	8000	315	
EAMM-A-T42-60AB	EPCC, EGSC, ELGC-BS, ELGC-TB	9.5	3.2	8000	314	
EAMM-A-T42-60P	EPCC, EGSC, ELGC-BS, ELGC-TB	10	3.2	8000	330	
EAMM-A-T42-60R	EPCC, EGSC, ELGC-BS, ELGC-TB	10	3.2	8000	349	
EAMM-A-T42-60RA	EPCC, EGSC, ELGC-BS, ELGC-TB	10	3.2	8000	348	
EAMM-A-T42-67A	EGSC, ELGC-BS, ELGC-TB	8.5	3.2	8000	377	
EAMM-A-T42-80P	EPCC, EGSC, ELGC-BS, ELGC-TB	10	5.8	8000	500	
EAMM-A-T42-87A	EPCC, EGSC, ELGC-BS, ELGC-TB	10	3.2	8000	400	
EAMM-A-T46-60P	ELGC-BS, ELGC-TB, ELGT-BS	10	3.2	8000	410	
EAMM-A-T46-60R	ELGC-BS, ELGC-TB, ELGT-BS	10	3.2	8000	413	
EAMM-A-T46-60RA	ELGC-BS, ELGC-TB, ELGT-BS	10	3.2	8000	412	
EAMM-A-T46-67A	ELGC-BS, ELGC-TB, ELGT-BS	8.5	3.2	8000	478	
EAMM-A-T46-70A	ELGC-BS, ELGC-TB, ELGT-BS	10	3.2	8000	574	
EAMM-A-T46-70AA	ELGC-BS, ELGC-TB, ELGT-BS	10	3.2	8000	601	
EAMM-A-T46-80P	ELGC-BS, ELGC-TB, ELGT-BS	10	5.8	8000	840	
EAMM-A-T46-80PA	ELGC-BS, ELGC-TB, ELGT-BS	10	7.5	8000	917	
EAMM-A-T46-80PB	ELGC-BS, ELGC-TB, ELGT-BS	10	7.9	8000	923	
EAMM-A-T46-85AA	ELGC-BS, ELGC-TB, ELGT-BS	10	3.2	8000	817	
EAMM-A-T46-87A	ELGC-BS, ELGC-TB, ELGT-BS	10	3.2	8000	630	
EAMM-A-T46-100A	ELGC-BS, ELGC-TB, ELGT-BS	10	5.8	8000	1080	
EAMM-A-V20-28A	EPCC, EGSC	0.2	0.022	10000	27	
EAMM-A-V20-28AA	EPCC, EGSC	0.2	0.022	10000	25	
EAMM-A-V25-38AA	EPCC, EGSC, ELGC-BS	0.5	0.19	10000	94	
EAMM-A-V25-40P	EPCC, EGSC, ELGC-BS	0.5	0.19	10000	90	
EAMM-A-V25-40R	EPCC, EGSC, ELGC-BS	0.5	0.19	10000	107	
EAMM-A-V25-40RA	EPCC, EGSC, ELGC-BS	0.5	0.19	10000	94	
EAMM-A-V25-42A	EPCC, EGSC, ELGC-BS	0.5	0.19	10000	83	
EAMM-A-V25-42AB	EPCC, EGSC, ELGC-BS	0.5	0.19	10000	75	
EAMM-A-V32-38AA	EPCC, EGSC, ELGC-BS, ELGC-TB	1.5	0.18	10000	112	
EAMM-A-V32-40P	EPCC, EGSC, ELGC-BS, ELGC-TB	1.5	0.19	10000	110	
EAMM-A-V32-40R	EPCC, EGSC, ELGC-BS, ELGC-TB	1.5	0.19	10000	131	
EAMM-A-V32-40RA	EPCC, EGSC, ELGC-BS, ELGC-TB	1.5	0.19	10000	114	
EAMM-A-V32-42A	EPCC, EGSC, ELGC-BS, ELGC-TB	1.0	0.19	10000	120	
EAMM-A-V32-42AB	EPCC, EGSC, ELGC-BS, ELGC-TB	1.0	0.19	10000	130	
EAMM-A-V32-57A	EPCC, EGSC, ELGC-BS, ELGC-TB	1.5	0.19	10000	180	
EAMM-A-V32-58AA	EPCC, EGSC, ELGC-BS, ELGC-TB	1.5	1.06	10000	1192	
EAMM-A-V32-60AA	EPCC, EGSC, ELGC-BS, ELGC-TB	1.5	0.19	10000	203	
EAMM-A-V32-60P	EPCC, EGSC, ELGC-BS, ELGC-TB	1.5	1.00	10000	210	
EAMM-A-V32-60PA	EPCC, EGSC, ELGC-BS, ELGC-TB	1.5	1.00	10000	243	
EAMM-A-V32-60RA	EPCC, EGSC, ELGC-BS, ELGC-TB	1.5	1.00	10000	243	

Data sheet

Operating and environmental conditions		
Ambient temperature	[°C]	-10 ... +60
Storage temperature	[°C]	-25 ... +60
Degree of protection ¹⁾		
EAMM-A-...		IP40
EAMM-A-...S1		IP65
Relative humidity	[%]	0 ... 95
Corrosion resistance class CRC ²⁾		1
Note on materials		RoHS-compliant

1) Only in combination with attached motor and axis

2) Corrosion resistance class CRC 1 to Festo standard FN 940070

Low corrosion stress. Dry indoor application or transport and storage protection. Also applies to parts behind covers, in the non-visible interior area, and parts which are covered in the application (e.g. drive trunnions).

Data sheet

Dimensions (sample illustration)

Download CAD data → www.festo.com

ELCC-TB...

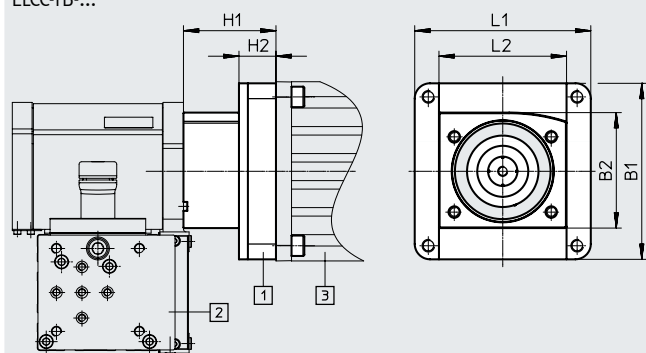

Main illustration:

- [1] Axial kit
- [2] Cantilever axis
- [3] Motor

Type	B1	B2	H1	H2	L1	L2
EAMM-A-N48-80P	84	56	53.5	39.5	84	65
EAMM-A-N48-100A	100	65	59	31.9	100	61
EAMM-A-N80-140A	138	100	72.5	29	138	90.5
EAMM-A-N48-60H	66	65	60	61	53.1	26
EAMM-A-N48-80G	100	65	100	61	59.1	32
EAMM-A-N80-80G	100	100	100	90.5	62.5	19
EAMM-A-L95-80G-G2	140	140	140	120	66	17
EAMM-A-L95-120G-G2	114	140	114	120	81	32

Ordering data – Individual components

Axial kit	Comprising:			
	Motor flange	Coupling	Coupling housing	Screw set
Part no. Type	Part no. Type	Part no. Type	Part no. Type	Part no. Type
8063592 EAMM-A-N48-80P	–	558002 EAMD-42-40-19-16X25	5204317 EAMK-A-N48-80P	–
1201894 EAMM-A-N48-100A	1201924 EAMF-A-48C-100A	558002 EAMD-42-40-19-16X25	1345949 EAMK-A-N48-48C	1201874 EAHM-L5-M6-50
1201691 EAMM-A-N80-140A	1190796 EAMF-A-80A-140A	558005 EAMD-56-46-24-23X27	1345953 EAMK-A-N80-80A	1201751 EAHM-L5-M8-75
1456618 EAMM-A-N48-60H	1460111 EAMF-A-48C-60G/H	1377840 EAMD-32-32-14-16X20	1345949 EAMK-A-N48-48C	4984529 EAHM-L5-M6-45
1258793 EAMM-A-N48-80G	1190375 EAMF-A-48C-80G	1781043 EAMD-42-40-20-16X25-U	1345949 EAMK-A-N48-48C	1201874 EAHM-L5-M6-50
2372096 EAMM-A-N80-80G	2372201 EAMF-A-80A-80G	558004 EAMD-56-46-20-23X27	1345953 EAMK-A-N80-80A	1201712 EAHM-L5-M8-60
3660191 EAMM-A-L95-80G-G2	3305700 EAMF-A-95B-80G	3717812 EAMD-67-51-20-32X32-U	3712650 EAMK-A-L9595A/BG2	–
3659941 EAMM-A-L95-120G-G2	3659724 EAMF-A-95A-120G-G2	558006 EAMD-75-125-32X32-U	3712650 EAMK-A-L95-95A/BG2	567496 EAHM-L2-M8-70

Data sheet

Dimensions (sample illustration)

Download CAD data → www.festo.com

EGSL...

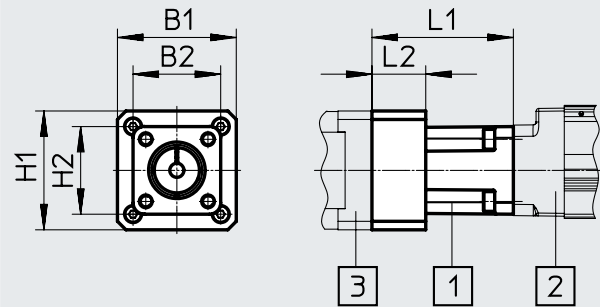

Main illustration:

- [1] Axial kit
- [2] Mini slide
- [3] Motor

ESBF... with degree of protection IP40

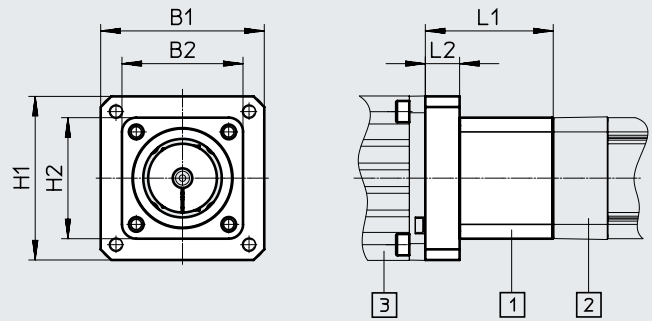

Main illustration:

- [1] Axial kit
- [2] Electric cylinder
- [3] Motor

ERMB...

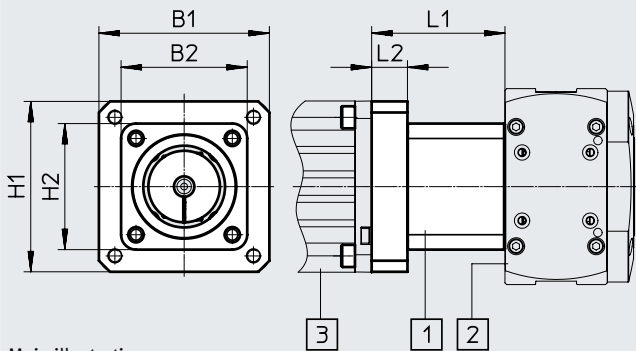

Main illustration:

- [1] Axial kit
- [2] Rotary module
- [3] Motor

EHMB...

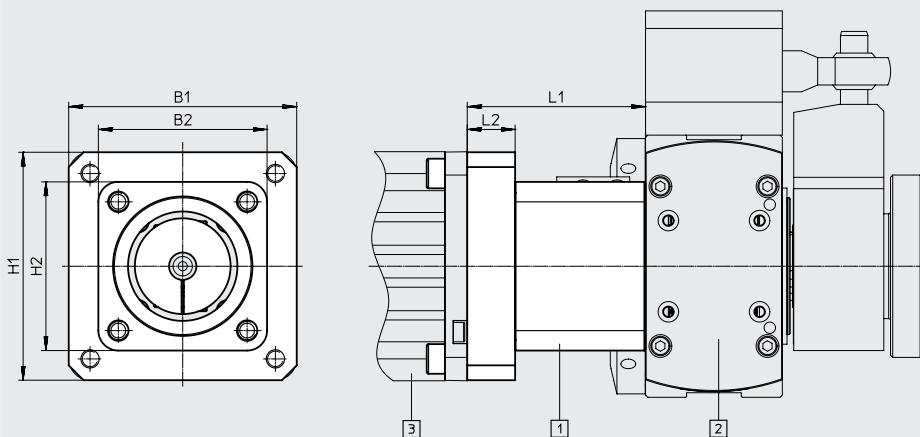

Main illustration:

- [1] Axial kit
- [2] Rotary lifting module
- [3] Motor

Data sheet

Type	B1	B2	H1	H2	L1	L2
EAMM-A-D19-28A	30	31	30	31	46.2	15
EAMM-A-D19-38AA	38	31	38	31	51.2	20
EAMM-A-D19-40A	40	31	40	31	42.7	11.5
EAMM-A-D19-40P	39.7	31	39.7	31	45.7	14.5
EAMM-A-D19-40R	40	31	40	31	51.2	20
EAMM-A-D19-42A	42	31	42	31	50	19
EAMM-A-D32-35A-40A	–	40	–	40	46	–
EAMM-A-D32-35A-40P	–	39.7	–	39.7	49.5	–
EAMM-A-D32-40A	40	45	40	45	39.8	8.3
EAMM-A-D32-40G	60	45	60	45	62.5	24
EAMM-A-D32-40P	39.7	45	39.7	45	44	12.5
EAMM-A-D32-40R	53.5	45	53.5	45	49.8	11.1
EAMM-A-D32-42A	42	45	42	45	48	5
EAMM-A-D32-50GA	62	45	62	45	62.5	31.5
EAMM-A-D32-55A	55	45	55	45	49.2	10.5
EAMM-A-D32-57A	56.4	45	56.4	45	50.5	12
EAMM-A-D32-58AA	58	45	58	45	51.2	12.5
EAMM-A-D32-60AA	60	45	60	45	50.7	12
EAMM-A-D32-60G	75	45	75	45	66.5	28
EAMM-A-D32-60H	75	45	75	45	66.5	28
EAMM-A-D32-60P	61.4	45	61.4	45	59.7	21
EAMM-A-D32-60R	62	45	62	45	51	20
EAMM-A-D32-60RA	62	45	62	45	51	20
EAMM-A-D32-67A	67	45	67	45	54.6	16
EAMM-A-D40-40G	50	53.5	50	53.5	55.5	17
EAMM-A-D40-40G-G2	60	53.5	60	53.5	62.5	24
EAMM-A-D40-50GA	62	54	62	54	62.5	31.5
EAMM-A-D40-55A	55	53.5	55	53.5	49.2	10.5
EAMM-A-D40-57A	56.4	53.5	56.4	53.5	50.5	12
EAMM-A-D40-58AA	58	54.8	58	54.8	51.2	12.5
EAMM-A-D40-60AA	60	54.8	60	54.8	50.7	12
EAMM-A-D40-60G	75	53.5	75	53.5	66.5	28
EAMM-A-D40-60H	75	53.5	75	53.5	66.5	28
EAMM-A-D40-60P	61.4	53.5	61.4	53.5	59.7	21
EAMM-A-D40-60R	62	54	62	54	51	20
EAMM-A-D40-60RA	62	54	62	54	51	20
EAMM-A-D40-67A	67	53.5	67	53.5	54.6	16
EAMM-A-D40-70A	70	53.5	70	53.5	52	13.5
EAMM-A-D40-70AA	72	54.8	72	54.8	51.5	13
EAMM-A-D40-87A	85.8	53.5	85.8	53.5	54	15.5

Data sheet

Dimensions (sample illustration)

Download CAD data → www.festo.com

EGSL...

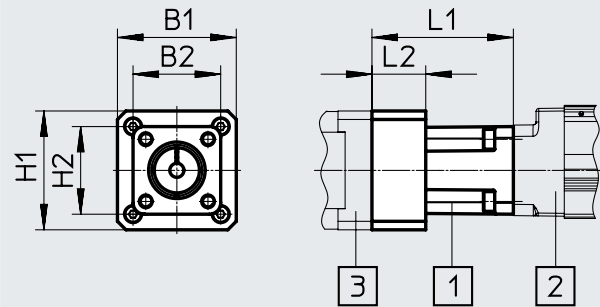

Main illustration:

- [1] Axial kit
- [2] Mini slide
- [3] Motor

ESBF... with degree of protection IP40

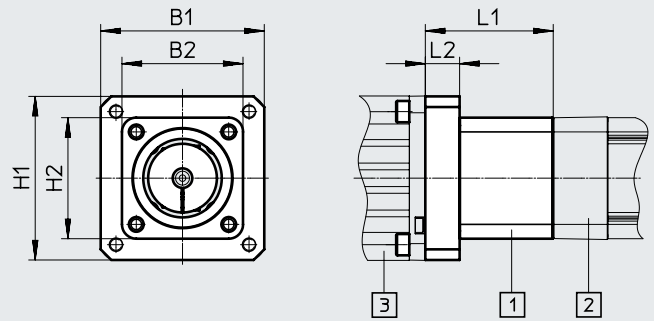

Main illustration:

- [1] Axial kit
- [2] Electric cylinder
- [3] Motor

ERMB...

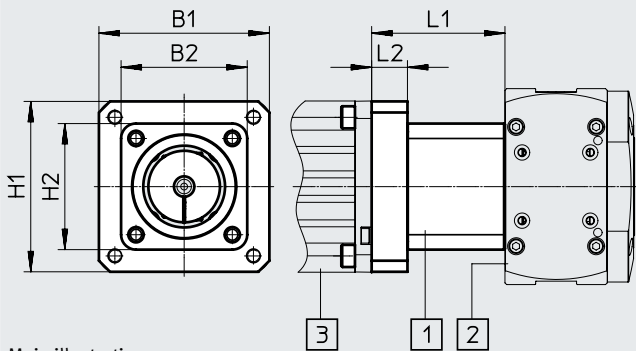

Main illustration:

- [1] Axial kit
- [2] Rotary module
- [3] Motor

EHMB...

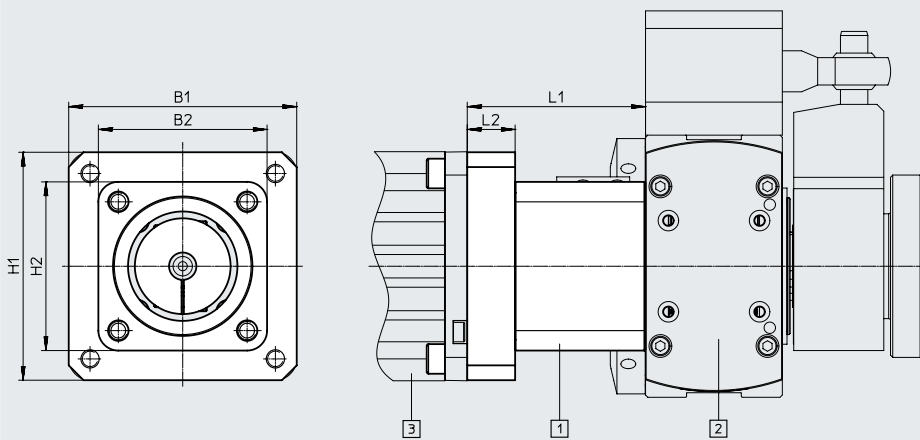

Main illustration:

- [1] Axial kit
- [2] Rotary lifting module
- [3] Motor

Data sheet

Type	B1	B2	H1	H2	L1	L2
EAMM-A-D50-60G	90	74	90	74	87.7	35
EAMM-A-D50-60H	90	74	90	74	87.7	35
EAMM-A-D50-70A	70	74	70	74	68.2	16.2
EAMM-A-D50-70GA	85.8	65	85.8	65	83.7	31.5
EAMM-A-D50-80G	101	74	101	74	92.4	30
EAMM-A-D50-80P	81.3	74	81.3	74	79.7	17.5
EAMM-A-D50-80PB	81.3	65	81.3	65	79.7	17.5
EAMM-A-D50-82AA	82	65	82	65	68.2	16
EAMM-A-D50-84AA	96	65	96	65	79.7	17.5
EAMM-A-D50-87A	85.8	74	85.8	74	69.7	17.5
EAMM-A-D50-100A	100	74	100	74	84.2	21.5
EAMM-A-D60-60G	70	74	70	74	71.4	24
EAMM-A-D60-60G-G2	90	74	90	74	82.4	35
EAMM-A-D60-60H	90	74	90	74	82.4	35
EAMM-A-D60-70A	70	74	70	74	63.2	16
EAMM-A-D60-80G	101	74	101	74	87.4	30
EAMM-A-D60-80P	81.3	74	81.3	74	74.7	17.5
EAMM-A-D60-80PB	81.3	74	81.3	74	74.7	17.5
EAMM-A-D60-84AA	96	74	96	74	74.7	17.5
EAMM-A-D60-87A	85.8	74	85.8	74	64.7	17.5
EAMM-A-D60-90GA	104	75	104	75	93.9	38.5
EAMM-A-D60-100A	100	74	100	74	78.2	21
EAMM-A-D80-80G	101	100	100	100	102	30
EAMM-A-D80-84AA	100	100	100	100	85.2	13
EAMM-A-D80-90GA	104	100	104	100	108.5	36.5
EAMM-A-D80-100A	100	100	100	100	92	20
EAMM-A-D80-140A	140.5	100	140.5	100	102	30
EAMM-A-D100-100A	100	112	100	112	99.5	20
EAMM-A-D100-120G	143	112	143	112	111.5	32
EAMM-A-D100-140A	140.5	112	140.5	112	109.5	30

Data sheet

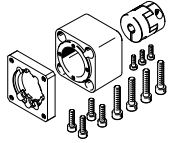
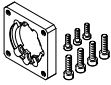
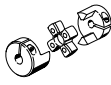
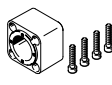
Ordering data – Individual components			
Axial kit	Comprising:		
	Motor flange	Coupling	Coupling housing
			
Part no. Type	Part no. Type	Part no. Type	Part no. Type
1081659 EAMM-A-D19-28A	1087613 EAMF-A-28D-28A	562676 EAMC-16-20-5-5	1087585 EAMK-A-D19-28D
1199152 EAMM-A-D19-40A	1199144 EAMF-A-28D-40A	543419 EAMC-16-20-5-6	1087585 EAMK-A-D19-28D
1981953 EAMM-A-D19-40P	1982014 EAMF-A-28D-40P	562677 EAMC-16-20-5-8	1087585 EAMK-A-D19-28D
1087642 EAMM-A-D19-42A	1087630 EAMF-A-28D-42A	562676 EAMC-16-20-5-5	1087585 EAMK-A-D19-28D
560281 EAMM-A-D32-35A-40A	–	558312 EAMC-30-32-6-6	560280 EAMK-A-D32-35A-40A
2207441 EAMM-A-D32-35A-40P	–	533708 EAMC-30-32-6-8	2207509 EAMK-A-D32-35A-40P
543147 EAMM-A-D32-40A	552163 EAMF-A-28B-40A	543420 EAMC-16-20-6-6	552155 EAMK-A-D32-28B
1454238 EAMM-A-D32-40G	1460095 EAMF-A-44C-40G-S1	562681 EAMC-30-32-6-10	551006 EAMK-A-D32-44A/C
★ 1976465 EAMM-A-D32-40P	1976704 EAMF-A-28B-40P	1232854 EAMC-16-20-6-8	552155 EAMK-A-D32-28B
★ 543148 EAMM-A-D32-42A	552164 EAMF-A-28B-42A	543419 EAMC-16-20-5-6	552155 EAMK-A-D32-28B
550979 EAMM-A-D32-55A	529942 EAMF-A-44A/B-55A	551003 EAMC-30-32-6-9	551006 EAMK-A-D32-44A/C
★ 550980 EAMM-A-D32-57A	530081 EAMF-A-44A/B-57A	551002 EAMC-30-32-6-6.35	551006 EAMK-A-D32-44A/C
2946758 EAMM-A-D32-60G	1460105 EAMF-A-44C-60G/H-S1	318577 EAMC-30-32-6-11	551006 EAMK-A-D32-44A/C
2946760 EAMM-A-D32-60H	1460105 EAMF-A-44C-60G/H-S1	1233256 EAMC-30-32-6-14	551006 EAMK-A-D32-44A/C
★ 1956054 EAMM-A-D32-60P	1956846 EAMF-A-44C-60P	1233256 EAMC-30-32-6-14	551006 EAMK-A-D32-44A/C
1454239 EAMM-A-D32-67A	1476305 EAMF-A-44A/B/C-67A-S1	551003 EAMC-30-32-6-9	551006 EAMK-A-D32-44A/C

Festo core product range



Generally ready for shipping ex works in 24 hours

Generally ready for shipping ex works in 5 days

Data sheet

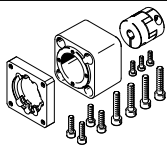
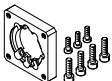
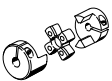
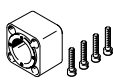
Ordering data – Individual components			
Axial kit	Comprising:		
	Motor flange	Coupling	Coupling housing
			
Part no. Type	Part no. Type	Part no. Type	Part no. Type
★ 560282 EAMM-A-D40-40G	550986 EAMF-A-44A/B-40G	558029 EAMC-30-32-8-10	552157 EAMK-A-D40-44A/C
2256398 EAMM-A-D40-40G-G2	1460095 EAMF-A-44C-40G-S1	558029 EAMC-30-32-8-10	552157 EAMK-A-D40-44A/C
543153 EAMM-A-D40-55A	529942 EAMF-A-44A/B-55A	543423 EAMC-30-32-8-9	552157 EAMK-A-D40-44A/C
★ 543154 EAMM-A-D40-57A	530081 EAMF-A-44A/B-57A	543421 EAMC-30-32-6.35-8	552157 EAMK-A-D40-44A/C
2256400 EAMM-A-D40-60G	1460105 EAMF-A-44C-60G/H-S1	551004 EAMC-30-32-8-11	552157 EAMK-A-D40-44A/C
1454242 EAMM-A-D40-60H	1460105 EAMF-A-44C-60G/H-S1	562682 EAMC-30-32-8-14	552157 EAMK-A-D40-44A/C
★ 1977000 EAMM-A-D40-60P	1956846 EAMF-A-44C-60P	562682 EAMC-30-32-8-14	552157 EAMK-A-D40-44A/C
1454243 EAMM-A-D40-67A	1476305 EAMF-A-44A/B/C-67A-S1	543423 EAMC-30-32-8-9	552157 EAMK-A-D40-44A/C
550981 EAMM-A-D40-70A	529943 EAMF-A-44A/B-70A	551004 EAMC-30-32-8-11	552157 EAMK-A-D40-44A/C
★ 550982 EAMM-A-D40-87A	530082 EAMF-A-44A/B-87A	551004 EAMC-30-32-8-11	552157 EAMK-A-D40-44A/C
2733786 EAMM-A-D50-60G	2256289 EAMF-A-64B-60G/H-S1	543424 EAMC-42-50-11-12	2733780 EAMK-A-D50-64B
2733796 EAMM-A-D50-60H	2256289 EAMF-A-64B-60G/H-S1	1455671 EAMC-42-50-12-14	2733780 EAMK-A-D50-64B
2733783 EAMM-A-D50-70A	529945 EAMF-A-64A/B-70A	543424 EAMC-42-50-11-12	2733780 EAMK-A-D50-64B
2733787 EAMM-A-D50-80G	2843290 EAMF-A-64C-80G-S1	2138701 EAMC-42-50-12-20	2836865 EAMK-A-D50-64C
★ 2733785 EAMM-A-D50-80P	1977113 EAMF-A-64A/C-80P	551005 EAMC-42-50-12-19	2836865 EAMK-A-D50-64C
★ 2733781 EAMM-A-D50-87A	533140 EAMF-A-64A/B-87A	543424 EAMC-42-50-11-12	2733780 EAMK-A-D50-64B
★ 2733784 EAMM-A-D50-100A	529947 EAMF-A-64A/C/D-100A	551005 EAMC-42-50-12-19	2836865 EAMK-A-D50-64C

Festo core product range



Generally ready for shipping ex works in 24 hours

Generally ready for shipping ex works in 5 days

Data sheet

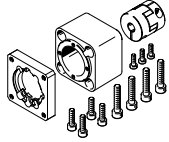
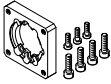
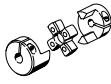
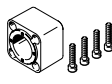
Ordering data – Individual components			
Axial kit	Comprising:		
	Motor flange	Coupling	Coupling housing
			
Part no. Type	Part no. Type	Part no. Type	Part no. Type
★ 560283 EAMM-A-D60-60G	550987 EAMF-A-64A/B-60G/H	543424 EAMC-42-50-11-12	552160 EAMK-A-D60-64B
2256696 EAMM-A-D60-60G-G2	2256289 EAMF-A-64B-60G/H-S1	543424 EAMC-42-50-11-12	552160 EAMK-A-D60-64B
1454245 EAMM-A-D60-60H	2256289 EAMF-A-64B-60G/H-S1	1455671 EAMC-42-50-12-14	552160 EAMK-A-D60-64B
543161 EAMM-A-D60-70A	529945 EAMF-A-64A/B-70A	543424 EAMC-42-50-11-12	552160 EAMK-A-D60-64B
1499402 EAMM-A-D60-80G	2843290 EAMF-A-64C-80G-S1	2138701 EAMC-42-50-12-20	551007 EAMK-A-D60-64C
★ 1977073 EAMM-A-D60-80P	1977113 EAMF-A-64A/C-80P	551005 EAMC-42-50-12-19	551007 EAMK-A-D60-64C
★ 543162 EAMM-A-D60-87A	533140 EAMF-A-64A/B-87A	543424 EAMC-42-50-11-12	552160 EAMK-A-D60-64B
★ 550983 EAMM-A-D60-100A	529947 EAMF-A-64A/C/D-100A	551005 EAMC-42-50-12-19	551007 EAMK-A-D60-64C
2946763 EAMM-A-D80-80G	2933286 EAMF-A-77A-80G-S1	3181801 EAMC-56-58-19-20	1593627 EAMK-A-D80-77A
1589665 EAMM-A-D80-100A	1593628 EAMF-A-77A-100A	1485673 EAMC-56-58-19-19	1593627 EAMK-A-D80-77A
1588299 EAMM-A-D80-140A	1593636 EAMF-A-77A-140A	1485674 EAMC-56-58-19-24	1593627 EAMK-A-D80-77A
3356796 EAMM-A-D100-100A	1593628 EAMF-A-77A-100A	1485674 EAMC-56-58-19-24	1593914 EAMK-A-D100-77A/B
2449341 EAMM-A-D100-120G	2449380 EAMF-A-77B-120G-S1	3187895 EAMC-67-62-24-25	1593914 EAMK-A-D100-77A/B
1588349 EAMM-A-D100-140A	1593636 EAMF-A-77A-140A	1451407 EAMC-67-62-24-24	1593914 EAMK-A-D100-77A/B

Festo core product range

- ★ Generally ready for shipping ex works in 24 hours
- ★ Generally ready for shipping ex works in 5 days

Data sheet

Dimensions (sample illustration)

Download CAD data → www.festo.com

ESBF... with degree of protection IP65

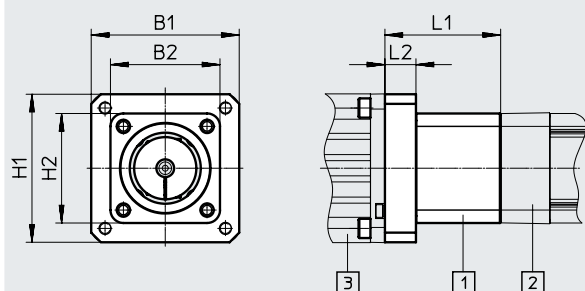

Main illustration:

- [1] Axial kit
- [2] Electric cylinder
- [3] Motor

Type	B1	B2	H1	H2	L1	L2
EAMM-A-D32-40A-S1	40	45	40	45	41.3	8.8
EAMM-A-D32-40G-S1	60	45	60	45	62.5	24
EAMM-A-D32-40P-S1	39.7	45	39.7	45	45.5	13
EAMM-A-D32-42A-S1	42	45	42	45	49.5	5.5
EAMM-A-D32-55A-S1	55	45	55	45	50.7	11
EAMM-A-D32-57A-S1	56.4	45	56.4	45	52	12.5
EAMM-A-D32-60G-S1	75	45	75	45	67.5	28.5
EAMM-A-D32-60H-S1	75	45	75	45	67.5	28.5
EAMM-A-D32-60P-S1	61.4	45	61.4	45	60.7	21
EAMM-A-D32-67A-S1	67	45	67	45	55.6	16
EAMM-A-D40-40G-S1	60	53.5	60	53.5	63.5	24.5
EAMM-A-D40-55A-S1	55	53.5	55	53.5	50.7	11
EAMM-A-D40-57A-S1	56.4	53.5	56.4	53.5	52	12.5
EAMM-A-D40-60G-S1	75	53.5	75	53.5	67.5	28.5
EAMM-A-D40-60H-S1	75	53.5	75	53.5	67.5	28.5
EAMM-A-D40-60P-S1	61.4	53.5	61.4	53.5	61.2	22
EAMM-A-D40-67A-S1	67	53.5	67	53.5	55.5	16.4
EAMM-A-D40-70A-S1	70	53.5	70	53.5	53.5	14
EAMM-A-D40-87A-S1	85.8	53.5	85.8	53.5	55.5	16
EAMM-A-D50-60G-S1	90	74	90	74	88.7	35.5
EAMM-A-D50-60H-S1	90	74	90	74	88.7	35.5
EAMM-A-D50-70A-S1	70	74	70	74	69.2	16.5
EAMM-A-D50-80G-S1	101	74	101	74	93.4	30.5
EAMM-A-D50-80P-S1	81.3	74	81.3	74	80.7	18
EAMM-A-D50-87A-S1	85.8	74	85.8	74	70.7	18
EAMM-A-D50-100A-S1	100	74	100	74	84.2	21.5
EAMM-A-D60-60G-S1	90	74	90	74	83.4	35.5
EAMM-A-D60-60H-S1	90	74	90	74	83.4	35.5
EAMM-A-D60-70A-S1	70	74	70	74	65	16.5
EAMM-A-D60-80G-S1	101	74	101	74	88.4	30.5
EAMM-A-D60-80P-S1	81.3	74	81.3	74	75.7	18
EAMM-A-D60-87A-S1	85.8	74	85.8	74	66.5	18
EAMM-A-D60-100A-S1	100	74	100	74	80	21.5
EAMM-A-D80-80G-S1	101	100	101	100	103.5	30.5
EAMM-A-D80-100A-S1	100	100	100	100	93.5	20.5
EAMM-A-D80-140A-S1	140.5	100	140.5	100	103.5	30.5
EAMM-A-D100-100A-S1	100	112	100	112	101	20
EAMM-A-D100-120G-S1	143	112	143	112	113	32.5
EAMM-A-D100-140A-S1	140.5	112	140.5	112	111	30.5

Data sheet

Ordering data – Individual components				
Axial kit	Comprising:			
	Motor flange	Coupling	Coupling housing	Seal set
Part no. Type	Part no. Type	Part no. Type	Part no. Type	Part no. Type
1322178 EAMM-A-D32-40A-S1	552163 EAMF-A-28B-40A	543420 EAMC-16-20-6-6	552155 EAMK-A-D32-28B	1561526 EADS-F-D32-40A
2256396 EAMM-A-D32-40G-S1	1460095 EAMF-A-44C-40G-S1	562681 EAMC-30-32-6-10	551006 EAMK-A-D32-44A/C	2253500 EADS-F-D32-40G
2207372 EAMM-A-D32-40P-S1	1976704 EAMF-A-28B-40P	1232854 EAMC-16-20-6-8	552155 EAMK-A-D32-28B	2207219 EADS-F-D32-40P
1322179 EAMM-A-D32-42A-S1	552164 EAMF-A-28B-42A	543419 EAMC-16-20-5-6	552155 EAMK-A-D32-28B	1561527 EADS-F-D32-42A
1322180 EAMM-A-D32-55A-S1	529942 EAMF-A-44A/B-55A	551003 EAMC-30-32-6-9	551006 EAMK-A-D32-44A/C	1561528 EADS-F-D32-55A
1322181 EAMM-A-D32-57A-S1	530081 EAMF-A-44A/B-57A	551002 EAMC-30-32-6-6.35	551006 EAMK-A-D32-44A/C	1561529 EADS-F-D32-57A
2946759 EAMM-A-D32-60G-S1	1460105 EAMF-A-44C-60G/H-S1	3187577 EAMC-30-32-6-11	551006 EAMK-A-D32-44A/C	8022150 EADS-F-D32-60G/H
2946761 EAMM-A-D32-60H-S1	1460105 EAMF-A-44C-60G/H-S1	1233256 EAMC-30-32-6-14	551006 EAMK-A-D32-44A/C	8022150 EADS-F-D32-60G/H
2234020 EAMM-A-D32-60P-S1	1956846 EAMF-A-44C-60P	1233256 EAMC-30-32-6-14	551006 EAMK-A-D32-44A/C	2234012 EADS-F-D32-60P
2256397 EAMM-A-D32-67A-S1	1476305 EAMF-A-44A/B/C-67A-S1	551003 EAMC-30-32-6-9	551006 EAMK-A-D32-44A/C	2253501 EADS-F-D32-67A
2256399 EAMM-A-D40-40G-S1	1460095 EAMF-A-44C-40G-S1	558029 EAMC-30-32-8-10	552157 EAMK-A-D40-44A/C	2253502 EADS-F-D40-40G
1322182 EAMM-A-D40-55A-S1	529942 EAMF-A-44A/B-55A	543423 EAMC-30-32-8-9	552157 EAMK-A-D40-44A/C	1561530 EADS-F-D40-55A
1322183 EAMM-A-D40-57A-S1	530081 EAMF-A-44A/B-57A	543421 EAMC-30-32-6.35-8	552157 EAMK-A-D40-44A/C	1561531 EADS-F-D40-57A
2256409 EAMM-A-D40-60G-S1	1460105 EAMF-A-44C-60G/H-S1	551004 EAMC-30-32-8-11	552157 EAMK-A-D40-44A/C	2253503 EADS-F-D40-60G/H
2256401 EAMM-A-D40-60H-S1	1460105 EAMF-A-44C-60G/H-S1	562682 EAMC-30-32-8-14	552157 EAMK-A-D40-44A/C	2253503 EADS-F-D40-60G/H
2151519 EAMM-A-D40-60P-S1	1956846 EAMF-A-44C-60P	562682 EAMC-30-32-8-14	552157 EAMK-A-D40-44A/C	2151545 EADS-F-D40-60P
2256695 EAMM-A-D40-67A-S1	1476305 EAMF-A-44A/B/C-67A-S1	543423 EAMC-30-32-8-9	552157 EAMK-A-D40-44A/C	2253504 EADS-F-D40-67A
1322185 EAMM-A-D40-70A-S1	529943 EAMF-A-44A/B-70A	551004 EAMC-30-32-8-11	552157 EAMK-A-D40-44A/C	1561532 EADS-F-D40-70A
1322186 EAMM-A-D40-87A-S1	530082 EAMF-A-44A/B-87A	551004 EAMC-30-32-8-11	552157 EAMK-A-D40-44A/C	1561533 EADS-F-D40-87A

Data sheet

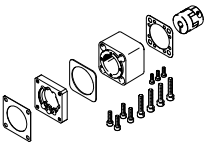
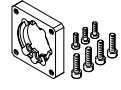
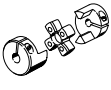
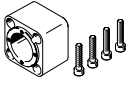
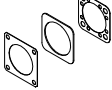
Ordering data – Individual components				
Axial kit	Comprising:			
	Motor flange	Coupling	Coupling housing	Seal set
				
Part no. Type	Part no. Type	Part no. Type	Part no. Type	Part no. Type
2734290 EAMM-A-D50-60G-S1	2256289 EAMF-A-64B-60G/H-S1	543424 EAMC-42-50-11-12	2733780 EAMK-A-D50-64B	2733792 EADS-F-D50-60G/H
2907418 EAMM-A-D50-60H-S1	2256289 EAMF-A-64B-60G/H-S1	1455671 EAMC-42-50-12-14	2733780 EAMK-A-D50-64B	2733792 EADS-F-D50-60G/H
2734287 EAMM-A-D50-70A-S1	529945 EAMF-A-64A/B-70A	543424 EAMC-42-50-11-12	2733780 EAMK-A-D50-64B	2733789 EADS-F-D50-70A
2734291 EAMM-A-D50-80G-S1	2843290 EAMF-A-64C-80G-S1	2138701 EAMC-42-50-12-20	2836865 EAMK-A-D50-64C	2733793 EADS-F-D50-80G
2734289 EAMM-A-D50-80P-S1	1977113 EAMF-A-64A/C-80P	551005 EAMC-42-50-12-19	2836865 EAMK-A-D50-64C	2733791 EADS-F-D50-80P
2734286 EAMM-A-D50-87A-S1	533140 EAMF-A-64A/B-87A	543424 EAMC-42-50-11-12	2733780 EAMK-A-D50-64B	2733788 EADS-F-D50-87A
2734288 EAMM-A-D50-100A-S1	529947 EAMF-A-64A/C/D-100A	551005 EAMC-42-50-12-19	2836865 EAMK-A-D50-64C	2733790 EADS-F-D50-100A
2256698 EAMM-A-D60-60G-S1	2256289 EAMF-A-64B-60G/H-S1	543424 EAMC-42-50-11-12	552160 EAMK-A-D60-64B	2253505 EADS-F-D60-60G/H
2256697 EAMM-A-D60-60H-S1	2256289 EAMF-A-64B-60G/H-S1	1455671 EAMC-42-50-12-14	552160 EAMK-A-D60-64B	2253505 EADS-F-D60-60G/H
2256699 EAMM-A-D60-70A-S1	529945 EAMF-A-64A/B-70A	543424 EAMC-42-50-11-12	552160 EAMK-A-D60-64B	8022145 EADS-F-D60-70A
2946762 EAMM-A-D60-80G-S1	2843290 EAMF-A-64C-80G-S1	2138701 EAMC-42-50-12-20	551007 EAMK-A-D60-64C	8022146 EADS-F-D60-80G
2218564 EAMM-A-D60-80P-S1	1977113 EAMF-A-64A/C-80P	551005 EAMC-42-50-12-19	551007 EAMK-A-D60-64C	2218523 EADS-F-D60-80P
1322188 EAMM-A-D60-87A-S1	533140 EAMF-A-64A/B-87A	543424 EAMC-42-50-11-12	552160 EAMK-A-D60-64B	1561536 EADS-F-D60-87A
2256700 EAMM-A-D60-100A-S1	529947 EAMF-A-64A/C/D-100A	551005 EAMC-42-50-12-19	551007 EAMK-A-D60-64C	2253507 EADS-F-D60-100A
2946764 EAMM-A-D80-80G-S1	2933286 EAMF-A-77A-80G-S1	3181801 EAMC-56-58-19-20	1593627 EAMK-A-D80-77A	8022147 EADS-F-D80-80G
1600673 EAMM-A-D80-100A-S1	1593628 EAMF-A-77A-100A	1485673 EAMC-56-58-19-19	1593627 EAMK-A-D80-77A	1593617 EADS-F-D80-100A
1600674 EAMM-A-D80-140A-S1	1593636 EAMF-A-77A-140A	1485674 EAMC-56-58-19-24	1593627 EAMK-A-D80-77A	1593671 EADS-F-D80-140A
3356931 EAMM-A-D100-100A-S1	1593628 EAMF-A-77A-100A	1485674 EAMC-56-58-19-24	1593914 EAMK-A-D100-77A/B	3356966 EADS-F-D100-100A
2946765 EAMM-A-D100-120G-S1	2449380 EAMF-A-77B-120G-S1	3187895 EAMC-67-62-24-25	1593914 EAMK-A-D100-77A/B	8022148 EADS-F-D100-120G
1600675 EAMM-A-D100-140A-S1	1593636 EAMF-A-77A-140A	1451407 EAMC-67-62-24-24	1593914 EAMK-A-D100-77A/B	1593991 EADS-F-D100-140A

Data sheet

Dimensions (sample illustration)

Download CAD data → www.festo.com

EGC-TB-...

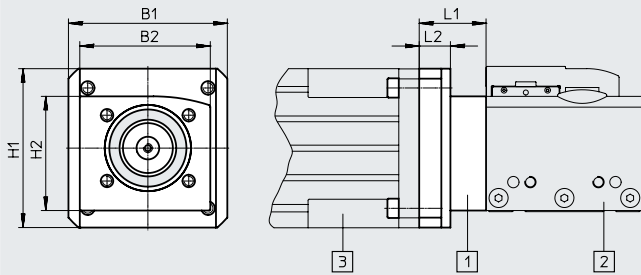

Main illustration:

- [1] Axial kit
- [2] Toothed belt axis
- [3] Motor

Type	B1	B2	H1	H2	L1	L2
EAMM-A-L27-40A	40	-	40	-	18.1	-
EAMM-A-L27-40G	50	40	50	50	28.7	-
EAMM-A-L27-40R	40	-	40	-	27.1	-
EAMM-A-L27-40RA	40	-	40	-	20.1	-
EAMM-A-L27-42A	58	38	42.5	38	26.1	22.1
EAMM-A-L27-50GA	55	55	55	39.5	26.6	21.6
EAMM-A-L27-55A	55	40	55	55	23.1	-
EAMM-A-L27-57A	56	39.5	56	56	23.1	-
EAMM-A-L27-57AA	56	56	56	39.5	23.1	18.1
EAMM-A-L27-57AB	56	56	56	39.5	23.1	18.1
EAMM-A-L27-57AC	56	56	56	39.5	23.1	18.1
EAMM-A-L27-58AA	55	55	55	39.5	22.1	17.1
EAMM-A-L27-60G	60	60	60	39.5	37.1	32.1
EAMM-A-L27-60RA	60	60	60	39.5	32.1	27.1
EAMM-A-L27-60RB	60	60	60	39.5	25.1	20.1
EAMM-A-L27-67A	67	41	67	67	28	-
EAMM-A-L38-40G	55	57.5	55	50.3	31.9	16.2
EAMM-A-L38-50GA	55	57.5	55	50.3	30.4	14.7
EAMM-A-L38-55A	55	57.5	55	50.3	26.7	11
EAMM-A-L38-56GA	56	57.5	56	50.3	44.9	29.2
EAMM-A-L38-57A	56	57.5	56	50.3	26.7	11
EAMM-A-L38-57AA	56	57.5	56	50.3	26.9	11.2
EAMM-A-L38-58AA	55	57.5	55	50.3	25.9	10.2
EAMM-A-L38-60AA	60	57.5	60	50.3	27.2	11.5
EAMM-A-L38-60PA	61.4	57.5	61.4	50.3	35.9	20.2
EAMM-A-L38-60R	61.4	57.5	61.4	50.3	36.7	21
EAMM-A-L38-60RB	61.4	57.5	61.4	50.3	28.9	13.2
EAMM-A-L38-60G	60	57.5	60	50.3	41.7	26
EAMM-A-L38-60H	60	57.5	60	50.3	41.7	24.5
EAMM-A-L38-60P	61.4	57.5	61.4	50.3	36.7	21
EAMM-A-L38-68GA	64	57.5	64	50.3	54.9	39.2
EAMM-A-L38-70A	70	57.5	70	50.3	29.5	13.8
EAMM-A-L38-70AA	70	57.5	70	50.3	35.9	20.2
EAMM-A-L38-70GA	73	57.5	73	50.3	41.9	26.2
EAMM-A-L38-72GA	72	57.5	72	50.3	54.9	24
EAMM-A-L38-84AA	96	57.5	96	50.3	45.9	30.2
EAMM-A-L38-87A	85.8	57.5	85.8	50.3	33.7	18
EAMM-A-L38-88A	88	57.5	88	50.3	35.9	20.2
EAMM-A-L48-40G	60	65	60	52	43.3	19.3
EAMM-A-L48-50GA	60	65	60	52	41.8	17.8
EAMM-A-L48-55A	55	60	55	52	37.3	24
EAMM-A-L48-56GA	56	65	56	52	56.3	32.3
EAMM-A-L48-60G	60	65	60	61	52.5	24.5
EAMM-A-L48-60H	60	65	60	61	52.5	24.5
EAMM-A-L48-60PA	61.4	65	61.4	61	47.3	19.3
EAMM-A-L48-68GA	64	65	64	61	65.3	37.3

Data sheet

Dimensions (sample illustration)

Download CAD data → www.festo.com

EGC-TB-...

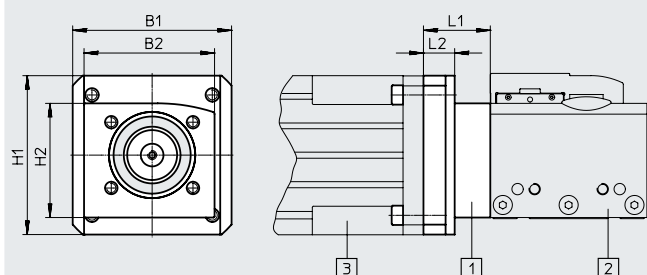

Main illustration:

- [1] Axial kit
- [2] Toothed belt axis
- [3] Motor

Type	B1	B2	H1	H2	L1	L2
EAMM-A-L48-70A	70	65	70	61	40.2	12.2
EAMM-A-L48-70AA	70	65	70	61	47.3	19.3
EAMM-A-L48-70GA	73	65	73	61	53.3	25.3
EAMM-A-L48-72GA	72	65	72	61	65.3	37.3
EAMM-A-L48-75GA	75	65	75	61	74.4	46.4
EAMM-A-L48-80G	80	65	80	61	58	30.4
EAMM-A-L48-80P	81.3	65	81.3	61	54	26
EAMM-A-L48-80PB	82	60	82	54	54	21
EAMM-A-L48-82AA	82	65	82	61	47.3	19.3
EAMM-A-L48-84AA	96	65	96	61	58.4	30.4
EAMM-A-L48-87A	85.8	65	85.8	61	44	16
EAMM-A-L48-88A	88	65	88	61	47.3	19.3
EAMM-A-L48-90GA	92	65	92	61	64.4	36.4
EAMM-A-L48-90R	90	65	90	61	52.3	24.3
EAMM-A-L48-92RA	90	65	90	61	57.3	29.3
EAMM-A-L48-100A	100.5	65	100.5	61	59	31
EAMM-A-L48-120GA	90	65	90	61	58.4	30.4
EAMM-A-L62-56GA	80	-	68	-	60.9	-
EAMM-A-L62-60H	80	-	68	-	56.9	-
EAMM-A-L62-68GA	92	92	66	75	69.9	37.9
EAMM-A-L62-72GA	92	92	72	75	69.9	37.9
EAMM-A-L62-70GA	76	-	74	-	56.4	-
EAMM-A-L62-75GA	92	-	75	-	77.9	-
EAMM-A-L62-80G	100	100	100	90.5	62.5	14.5
EAMM-A-L62-84AA	96	80	96	70	61.9	25.9
EAMM-A-L62-88A	88	80	88	70	51.9	19.9
EAMM-A-L62-100A	100.5	100	100.5	90.5	62.5	14.5
EAMM-A-L62-108AA	114	100	114	90.5	75.5	27.5
EAMM-A-L62-115GA	138	92	102	75	109.5	62.9
EAMM-A-L62-120G	120	92	120	75	74.9	52.9
EAMM-A-L62-120GA	92	92	92	75	61.9	29.9
EAMM-A-L62-120GB	120	92	120	75	71.9	15.9
EAMM-A-L62-120GC	132	92	132	75	89.9	20.9
EAMM-A-L62-140A	140	100	140	90.5	72.5	24.5
EAMM-A-L95-68GA	138	140	102	120	73.4	24.4
EAMM-A-L95-72GA	138	140	102	120	73.4	24.4
EAMM-A-L95-75GA	138	140	102	120	81.4	32.4
EAMM-A-L95-90GA	138	140	102	120	71.4	22.4
EAMM-A-L95-115GA	138	-	102	-	113.4	-
EAMM-A-L95-120GB	138	140	122	120	75.5	26.4
EAMM-A-L95-120G-G2	114	140	114	120	81	32
EAMM-A-L95-140A-G2	140	140	140	120	76	27
EAMM-A-L95-190A-G2	190	140	190	120	86	37

Data sheet

Dimensions (sample illustration)

Download CAD data → www.festo.com

EGC-TB-...

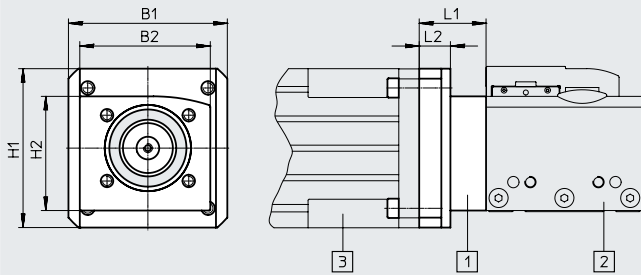

Main illustration:

- [1] Axial kit
- [2] Toothed belt axis
- [3] Motor

Type	B1	B2	H1	H2	L1	L2
EAMM-A-L62-56GA	80	-	68	-	60.9	-
EAMM-A-L62-60H	68	-	68	-	56.9	-
EAMM-A-L62-70GA	76	-	72	-	56.4	-
EAMM-A-L62-75GA	92	-	75	-	77.9	-
EAMM-A-L62-68GA	92	92	66	75	69.9	37.9
EAMM-A-L62-72GA	92	92	72	75	69.9	37.9
EAMM-A-L62-90GA	92	92	92	75	67.9	35.9
EAMM-A-L62-115GA	102	100	102	75	113.5	65.5
EAMM-A-L62-120G	120	92	120	75	76.9	44.9
EAMM-A-L62-120GA	92	92	92	75	61.9	29.9
EAMM-A-L62-120GB	120	92	-	75	71.9	39.9
EAMM-A-L62-120GC	124	92	-	75	91.9	59.9
EAMM-A-L95-75GA	138	140	102	120	91.4	32.4
EAMM-A-L95-68GA	138	140	102	120	73.4	24.4
EAMM-A-L95-72GA	138	140	102	120	73.4	24.4
EAMM-A-L95-90GA	138	140	102	120	71.4	22.4
EAMM-A-L95-115GA	138	140	102	120	113.4	64.4
EAMM-A-L95-120GA	138	140	102	120	65.4	16.4
EAMM-A-L95-120GB	138	140	122	120	75.4	26.4
EAMM-A-L95-120GC	140	140	124	120	95.4	46.4
EAMM-A-L95-160G	164	140	164	120	112	63



Ordering data – Individual components

Axial kit	Comprising:			
	Motor flange	Coupling	Coupling housing	Screw set
Part no. Type	Part no. Type	Part no. Type	Part no. Type	Part no. Type
★ 557974 EAMM-A-L27-40G	558015 EAMF-A-L27-40G	557998 EAMD-19-15-10-8X10	-	-
557975 EAMM-A-L27-55A	558016 EAMF-A-L27-55A	557999 EAMD-19-15-9-8X10	-	-
★ 560678 EAMM-A-L27-57A	560690 EAMF-A-L27-57A	561292 EAMD-16-15-6.35-8X10	-	-
1454261 EAMM-A-L27-67A	1460087 EAMF-A-L27-67A	557999 EAMD-19-15-9-8X10	-	-

Festo core product range

- ★ Generally ready for shipping ex works in 24 hours
- ★ Generally ready for shipping ex works in 5 days

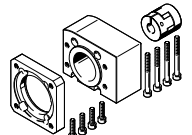
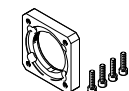
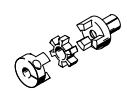
Data sheet

Ordering data – Individual components				
Axial kit	Comprising:			
	Motor flange	Coupling	Coupling housing	Screw set
				
Part no. Type	Part no. Type	Part no. Type	Part no. Type	Part no. Type
3683331 EAMM-A-L38-55A	558176 EAMF-A-38A-55A	3717923 EAMD-25-22-9-10X12	558011 EAMK-A-L38-38A	567484 EAHM-L2-M5-30
★ 560679 EAMM-A-L38-57A	560692 EAMF-A-38A-57A	561293 EAMD-25-22-6.35-10X12	558011 EAMK-A-L38-38A	567484 EAHM-L2-M5-30
★ 557978 EAMM-A-L38-60G	558017 EAMF-A-38A-60G/H	558000 EAMD-25-22-11-10X12	558011 EAMK-A-L38-38A	567485 EAHM-L2-M5-35
1456610 EAMM-A-L38-60H	558017 EAMF-A-38A-60G/H	1453861 EAMD-28-22-14-10X12	558011 EAMK-A-L38-38A	567485 EAHM-L2-M5-35
★ 2037246 EAMM-A-L38-60P	1987412 EAMF-A-38A-60P	1453861 EAMD-28-22-14-10X12	558011 EAMK-A-L38-38A	567485 EAHM-L2-M5-35
557979 EAMM-A-L38-70A	558018 EAMF-A-38A-70A	558000 EAMD-25-22-11-10X12	558011 EAMK-A-L38-38A	567484 EAHM-L2-M5-30
★ 560680 EAMM-A-L38-87A	560693 EAMF-A-38A-87A	558000 EAMD-25-22-11-10X12	558011 EAMK-A-L38-38A	567485 EAHM-L2-M5-35
★ 557983 EAMM-A-L48-60G	558019 EAMF-A-48A-60G/H	558001 EAMD-32-32-11-16X20	558012 EAMK-A-L48-48A	567487 EAHM-L2-M5-45
1456611 EAMM-A-L48-60H	558019 EAMF-A-48A-60G/H	1377840 EAMD-32-32-14-16X20	558012 EAMK-A-L48-48A	567487 EAHM-L2-M5-45
557982 EAMM-A-L48-70A	558025 EAMF-A-48A-70A	558001 EAMD-32-32-11-16X20	558012 EAMK-A-L48-48A	567486 EAHM-L2-M5-40
★ 2042616 EAMM-A-L48-80P	2043427 EAMF-A-48A-80P	558002 EAMD-42-40-19-16X25	558012 EAMK-A-L48-48A	567489 EAHM-L2-M5-55
★ 560683 EAMM-A-L48-87A	560695 EAMF-A-48A-87A	558001 EAMD-32-32-11-16X20	558012 EAMK-A-L48-48A	567487 EAHM-L2-M5-45
557984 EAMM-A-L48-100A	558020 EAMF-A-48A-100A	558002 EAMD-42-40-19-16X25	558012 EAMK-A-L48-48A	567489 EAHM-L2-M5-55
★ 557989 EAMM-A-L62-80G	558021 EAMF-A-62A-80G	558004 EAMD-56-46-20-23X27	558013 EAMK-A-L62-62A	567492 EAHM-L2-M6-65-L
★ 557988 EAMM-A-L62-100A	558026 EAMF-A-62A-100A	558003 EAMD-56-46-19-23X27	558013 EAMK-A-L62-62A	567491 EAHM-L2-M6-65
557990 EAMM-A-L62-140A	558022 EAMF-A-62A-140A	558005 EAMD-56-46-24-23X27	558013 EAMK-A-L62-62A	567493 EAHM-L2-M6-70
★ 3659941 EAMM-A-L95-120G-G2	3659724 EAMF-A-95A-120G-G2	558006 EAMD-67-51-25-32X32-U	3712650 EAMK-A-L95-95A/B-G2	567496 EAHM-L2-M8-70
3657226 EAMM-A-L95-140A-G2	558023 EAMF-A-95A-140A	558008 EAMD-67-51-24-32X32-U	3712650 EAMK-A-L95-95A/B-G2	567497 EAHM-L2-M8-80
3659562 EAMM-A-L95-190A-G2	1378473 EAMF-A-95A-190A	1379269 EAMD-67-51-32-32X32-U	3712650 EAMK-A-L95-95A/B-G2	567497 EAHM-L2-M8-80

Festo core product range



Generally ready for shipping ex works in 24 hours

Generally ready for shipping ex works in 5 days

Data sheet

Dimensions (sample illustration)

Download CAD data → www.festo.com

EGC-BS...

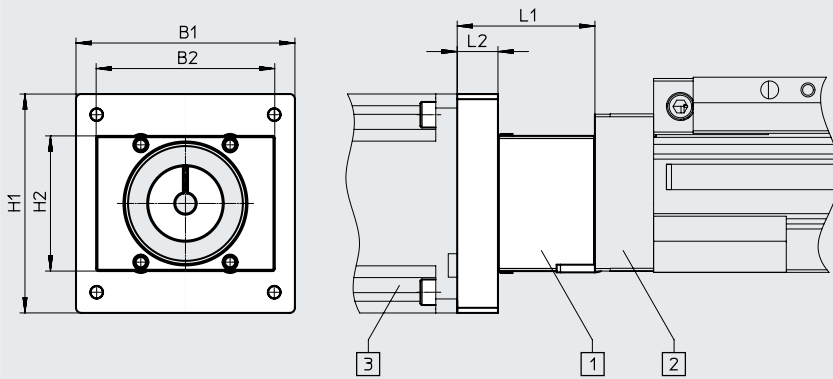

Main illustration:

- [1] Axial kit
- [2] Spindle axis
- [3] Motor

Type	B1	B2	H1	H2	L1	L2
EAMM-A-S38-40A-G2	58	55	44	44	44	7
EAMM-A-S38-40G-G2	60	55	60	44	54	17
EAMM-A-S38-40P-G2	58	55	44	44	44.7	10.7
EAMM-A-S38-42A-G2	58	55	44	44	52	15
EAMM-A-S38-50GA	62	62	62	62	59.8	22.8
EAMM-A-S38-55A-G2	55	55	55	44	48	11
EAMM-A-S38-57A-G2	56	55	56	55	48	11
EAMM-A-S38-58AA	58	55	58	44	47.6	10.6
EAMM-A-S38-60AA	60	55	60	44	48.5	11.5
EAMM-A-S38-60R	62	55	62	44	48.8	11.8
EAMM-A-S38-60RA	62	55	62	44	48.8	11.8
EAMM-A-S38-60P-G2	61.4	55	61.4	44	58	21
EAMM-A-S38-67A-G2	67	55	67	44	53	16
EAMM-A-S48-40G-G2	60	70	60	53	55	17
EAMM-A-S48-50GA	70	70	54	54	52	14
EAMM-A-S48-55A-G2	70	70	55	53	47.2	9.2
EAMM-A-S48-57A-G2	70	70	55	53	47.2	9.2
EAMM-A-S48-58AA	70	70	58	53	47.5	9.2
EAMM-A-S48-60AA	60	70	60	53	48.5	10.5
EAMM-A-S48-60G-G2	60	70	60	53	62.5	24.5
EAMM-A-S48-60H-G2	60	70	60	53	62.5	24.5
EAMM-A-S48-60P-G2	61.4	70	61.4	53	57.2	19.2
EAMM-A-S48-60RA	62	70	62	53	57.2	19.2
EAMM-A-S48-70A-G2	70	70	70	53	50.2	12.2
EAMM-A-S48-70AA	70	70	70	53	57.3	19.3
EAMM-A-S48-87A-G2	85.8	70	85.8	53	54	16
EAMM-A-S62-60G-G2	80	80	80	70	84.5	18
EAMM-A-S62-60H-G2	80	80	80	70	84.5	18
EAMM-A-S62-70A-G2	82	80	70	70	78.5	12
EAMM-A-S62-70GA	82	80	82	70	79.5	13
EAMM-A-S62-80G-G2	100	80	100	70	81	14.5
EAMM-A-S62-80P-G2	81.3	80	81.3	70	77	10.5

Festo core product range







Generally ready for shipping ex works in 24 hours

Generally ready for shipping ex works in 5 days

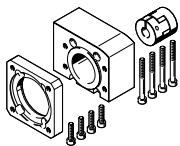
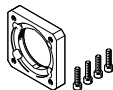

Data sheet

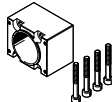
Type	B1	B2	H1	H2	L1	L2
EAMM-A-S62-80PB	82	80	82	70	77	10.5
EAMM-A-S62-82AA	82	80	82	70	79	12.5
EAMM-A-S62-84AA	84	80	84	70	81	14.5
EAMM-A-S62-87A-G2	85.8	80	85.8	70	81.5	15
EAMM-A-S62-100A-G2	100.5	80	100.5	70	81	14.5
EAMM-A-S62-140A-G2	140	80	140	70	91	24.5
EAMM-A-S95-84AA	140	140	110	110	85.5	17
EAMM-A-S95-90GA	140	140	110	110	94	21.9
EAMM-A-S95-100A-G2	140	140	100	110	85.5	17
EAMM-A-S95-140A-G2	140	140	140	110	95.5	27

Ordering data – Individual components

Axial kit	Comprising:			
	Motor flange	Coupling	Coupling housing	Screw set
				
Part no. Type	Part no. Type	Part no. Type	Part no. Type	Part no. Type
3637971 EAMM-A-S38-40A-G2	558175 EAMF-A-38B-40A	558312 EAMC-30-32-6-6	3637942 EAMK-A-S38-38A/B-G2	–
1456647 EAMM-A-S38-40G-G2	1460097 EAMF-A-38A-40G	562681 EAMC-30-32-6-10	3637942 EAMK-A-S38-38A/B-G2	567488 EAHM-L2-M5-50
★ 3637972 EAMM-A-S38-40P-G2	2219077 EAMF-A-38B-40P	533708 EAMC-30-32-6-8	3637942 EAMK-A-S38-38A/B-G2	–
★ 3637965 EAMM-A-S38-42A-G2	560691 EAMF-A-38B-42A	561333 EAMC-30-32-5-6	3637942 EAMK-A-S38-38A/B-G2	–
3637967 EAMM-A-S38-55A-G2	558176 EAMF-A-38A-55A	551003 EAMC-30-32-6-9	3637942 EAMK-A-S38-38A/B-G2	567488 EAHM-L2-M5-50
★ 3637956 EAMM-A-S38-57A-G2	560692 EAMF-A-38A-57A	551002 EAMC-30-32-6-6.35	3637942 EAMK-A-S38-38A/B-G2	567488 EAHM-L2-M5-50
★ 3637958 EAMM-A-S38-60P-G2	1987412 EAMF-A-38A-60P	1233256 EAMC-30-32-6-14	3637942 EAMK-A-S38-38A/B-G2	567489 EAHM-L2-M5-55
1456638 EAMM-A-S38-67A-G2	1490100 EAMF-A-38A-67A	551003 EAMC-30-32-6-9	3637942 EAMK-A-S38-38A/B-G2	567489 EAHM-L2-M5-55
1456650 EAMM-A-S48-40G-G2	4067069 EAMF-A-48B-40G	558029 EAMC-30-32-8-10	3637941 EAMK-A-S48-48A/B-G2	–
3637961 EAMM-A-S48-55A-G2	558177 EAMF-A-48B-55A	543423 EAMC-30-32-8-9	3637941 EAMK-A-S48-48A/B-G2	–
★ 3637963 EAMM-A-S48-57A-G2	560694 EAMF-A-48B-57A	543421 EAMC-30-32-6.35-8	3637941 EAMK-A-S48-48A/B-G2	–
2256701 EAMM-A-S48-60G-G2	558019 EAMF-A-48A-60G/H	551004 EAMC-30-32-8-11	3637941 EAMK-A-S48-48A/B-G2	567489 EAHM-L2-M5-55
1456652 EAMM-A-S48-60H-G2	558019 EAMF-A-48A-60G/H	562682 EAMC-30-32-8-14	3637941 EAMK-A-S48-48A/B-G2	567489 EAHM-L2-M5-55
★ 3637964 EAMM-A-S48-60P-G2	2220620 EAMF-A-48A-60P	562682 EAMC-30-32-8-14	3637941 EAMK-A-S48-48A/B-G2	567489 EAHM-L2-M5-55

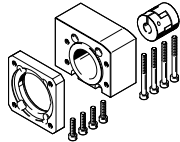
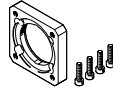
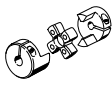
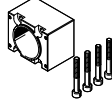
Data sheet

Ordering data – Individual components				
Axial kit	Comprising:			
	Motor flange	Coupling	Coupling housing	Screw set
				
Part no. Type	Part no. Type	Part no. Type	Part no. Type	Part no. Type
3637957 EAMM-A-S48-70A-G2	558025 EAMF-A-48A-70A	551004 EAMC-30-32-8-11	3637941 EAMK-A-S48-48A/B-G2	567488 EAHM-L2-M5-50
★ 3637962 EAMM-A-S48-87A-G2	560695 EAMF-A-48A-87A	551004 EAMC-30-32-8-11	3637941 EAMK-A-S48-48A/B-G2	567489 EAHM-L2-M5-55
2297649 EAMM-A-S62-60G-G2	1460112 EAMF-A-62A-60G/H	525864 EAMC-40-66-11-12	3637940 EAMK-A-S62-62A/B-G2	567495 EAHM-L2-M6-90
1456654 EAMM-A-S62-60H-G2	1460112 EAMF-A-62A-60G/H	1452803 EAMC-40-66-12-14	3637940 EAMK-A-S62-62A/B-G2	567495 EAHM-L2-M6-90
3637959 EAMM-A-S62-70A-G2	558179 EAMF-A-62B-70A	558313 EAMC-42-66-11-12	3637940 EAMK-A-S62-62A/B-G2	–
1972530 EAMM-A-S62-80G-G2	2116672 EAMF-A-62B-80G	2138701 EAMC-42-50-12-20	3637940 EAMK-A-S62-62A/B-G2	–
★ 3637970 EAMM-A-S62-80P-G2	2222624 EAMF-A-62B-80P	551005 EAMC-42-50-12-19	3637940 EAMK-A-S62-62A/B-G2	–
★ 3637966 EAMM-A-S62-87A-G2	560696 EAMF-A-62B-87A	558313 EAMC-42-66-11-12	3637940 EAMK-A-S62-62A/B-G2	–
★ 3637960 EAMM-A-S62-100A-G2	558026 EAMF-A-62A-100A	551005 EAMC-42-50-12-19	3637940 EAMK-A-S62-62A/B-G2	567494 EAHM-L2-M6-80
3637969 EAMM-A-S62-140A-G2	558022 EAMF-A-62A-140A	558314 EAMC-42-50-12-24	3637940 EAMK-A-S62-62A/B-G2	567495 EAHM-L2-M6-90
3637955 EAMM-A-S95-100A-G2	558182 EAMF-A-95B-100A	558315 EAMC-56-58-19-25	3637939 EAMK-A-S95-95A/B-G2	–
3637954 EAMM-A-S95-140A-G2	558023 EAMF-A-95A-140A	558316 EAMC-56-58-24-25	3637939 EAMK-A-S95-95A/B-G2	567498 EAHM-L2-M8-100

Festo core product range



Generally ready for shipping ex works in 24 hours

Generally ready for shipping ex works in 5 days

Data sheet

Dimensions (sample illustration)

Download CAD data → www.festo.com

ELGA-...TB

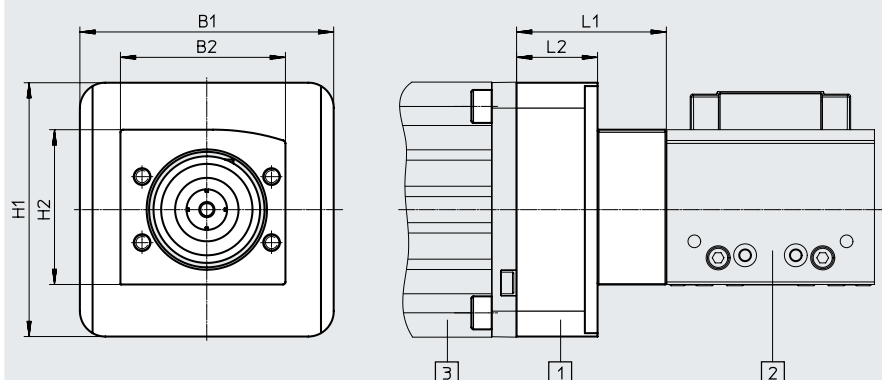

Main illustration:

- [1] Axial kit
- [2] Toothed belt axis
- [3] Motor

Type	B1	B2	H1	H2	L1	L2
EAMM-A-L95-80G-G2	140	140	140	120	66	17
EAMM-A-L95-120G-G2	114	140	114	120	81	32
EAMM-A-L95-140A-G2	140	140	140	120	76	27
EAMM-A-L95-190A-G2	190	140	190	120	86	37
EAMM-A-N38-60G	60	57.5	60	50.3	49.5	33
EAMM-A-N38-60H	60	57.5	60	50.3	49.5	33
EAMM-A-N38-70A	70	57.5	70	50.3	37.5	21
EAMM-A-N38-87A	85.5	57.5	85.5	50.3	42	25.5
EAMM-A-N48-60G	66	65	60	61	53.1	26
EAMM-A-N48-60H	66	65	60	61	53.1	26
EAMM-A-N48-80G	100	65	100	61	59.1	32
EAMM-A-N48-100A	100	65	100	61	59	31.9
EAMM-A-N80-80G	100	100	100	90.5	62.5	19
EAMM-A-N80-120G	124	100	124	90.5	77.5	34
EAMM-A-N80-140A	138	100	138	90.5	72.5	29
EAMM-A-L95-75GA	138	140	102	120	81.4	32.4
EAMM-A-L95-68GA	138	140	102	120	73.4	24.4
EAMM-A-L95-72GA	138	140	102	120	73.4	24.4
EAMM-A-L95-90GA	138	140	102	120	71.4	22.4
EAMM-A-L95-115GA	138	140	102	120	113.4	64.4
EAMM-A-L95-120GA	138	140	102	120	65.4	16.4
EAMM-A-L95-120GB	138	140	122	120	75.4	26.4
EAMM-A-L95-120GC	140	140	124	120	95.4	46.4
EAMM-A-L95-160G	164	140	164	120	112	63
EAMM-A-N38-60PA	61.4	56	61.4	50	44.4	32.4
EAMM-A-N38-60RA	61.4	56	61.4	50	44.4	32.4
EAMM-A-N38-70AA	70	56	70	50	44.4	32.4
EAMM-A-N38-88A	88	56	88	50	44.4	32.4
EAMM-A-N38-90R	90	56	90	50	49.4	37.4
EAMM-A-N38-92RA	90	56	90	50	54.4	42.4
EAMM-A-N38-40G	58	56	55	50	40.3	38.3
EAMM-A-N38-50GA	58	56	55	50	38.8	36.8
EAMM-A-N38-56GA	60	56	56	50	53.4	51.4
EAMM-A-N38-70GA	73	56	73	50	50.4	48.4
EAMM-A-N38-68GA	64	56	64	50	62.4	50.4
EAMM-A-N38-72GA	72	56	72	50	62.4	50.4

Data sheet

Dimensions (sample illustration)

Download CAD data → www.festo.com

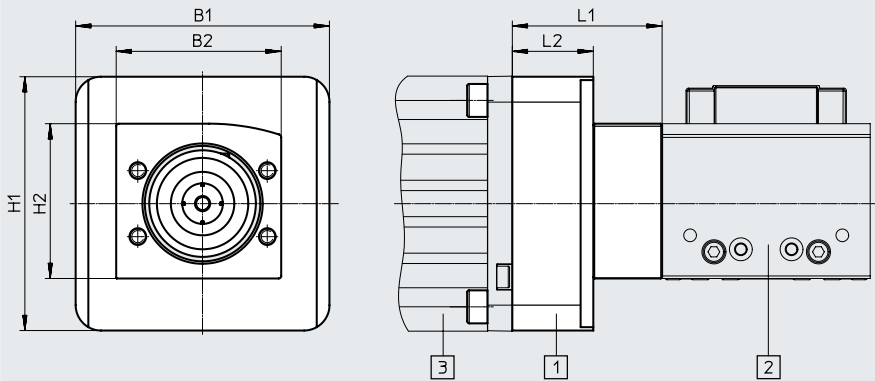

ELGA...-TB



- Main illustration:
 [1] Axial kit
 [2] Toothed belt axis
 [3] Motor

Type	B1	B2	H1	H2	L1	L2
EAMM-A-N48-60PA	66	65	66	56	48.5	34.5
EAMM-A-N48-70AA	70	65	70	56	48.5	34.5
EAMM-A-N48-80P	84	65	84	56	53.5	39.5
EAMM-A-N48-80PB	82	64	82	52	58	20
EAMM-A-N48-88A	88	65	88	56	48.5	34.5
EAMM-A-N48-84AA	96	65	96	56	58.5	44.5
EAMM-A-N48-50GA	68	65	58	56	43	29
EAMM-A-N48-56GA	68	65	58	56	57.5	53.5
EAMM-A-N48-70GA	73	65	73	56	54.5	50.5
EAMM-A-N48-75GA	75	65	75	56	74.5	43.5
EAMM-A-N48-68GA	68	65	68	56	66.5	35.5
EAMM-A-N48-72GA	72	65	72	56	66.5	35.5
EAMM-A-N48-90GA	92	65	92	56	64.5	60.5
EAMM-A-N48-90GB	92	65	92	56	58.5	54.5
EAMM-A-N48-120GA	90	65	90	56	58.5	44.5
EAMM-A-N80-84AA	96	92	96	82	62.5	48.5
EAMM-A-N80-100A	100	92	100	82	62.5	48.5
EAMM-A-N80-70GA	96	92	96	82	58	44
EAMM-A-N80-75GA	96	92	96	82	78.5	64.5
EAMM-A-N80-68GA	96	92	96	82	70	24.5
EAMM-A-N80-72GA	96	92	96	82	70	26.5
EAMM-A-N80-90GA	116	92	96	82	68.5	54.5
EAMM-A-N80-90GB	124	92	96	82	60.5	52.5
EAMM-A-N80-115GA	116	92	102	82	110.5	65
EAMM-A-N80-120GA	140	92	102	82	62.5	60.5
EAMM-A-N80-120GB	140	92	122	82	82.5	37
EAMM-A-N80-120GC	140	92	124	82	92.5	47

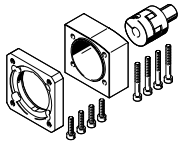
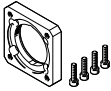
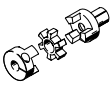
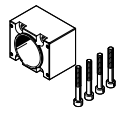
Data sheet

Ordering data – Individual components				
Axial kit	Comprising:			
	Motor flange	Coupling	Coupling housing	Screw set
				
Part no. Type	Part no. Type	Part no. Type	Part no. Type	Part no. Type
3660191 EAMM-A-L95-80G-G2	3305700 EAMF-A-95B-80G	3717812 EAMD-67-51-20-32X32-U	3712650 EAMK-A-L95-95A/B-G2	–
★ 3659941 EAMM-A-L95-120G-G2	3659724 EAMF-A-95A-120G-G2	558006 EAMD-67-51-25-32X32-U	3712650 EAMK-A-L95-95A/B-G2	567496 EAHM-L2-M8-70
3657226 EAMM-A-L95-140A-G2	558023 EAMF-A-95A-140A	558008 EAMD-67-51-24-32X32-U	3712650 EAMK-A-L95-95A/B-G2	567497 EAHM-L2-M8-80
3659562 EAMM-A-L95-190A-G2	1378473 EAMF-A-95A-190A	1379269 EAMD-67-51-32-32X32-U	3712650 EAMK-A-L95-95A/B-G2	567497 EAHM-L2-M8-80
★ 1202253 EAMM-A-N38-60G	1190015 EAMF-A-38D-60G/H	558001 EAMD-32-32-11-16X20	1345947 EAMK-A-N38-38D	1202262 EAHM-L5-M6-40
1456616 EAMM-A-N38-60H	1190015 EAMF-A-38D-60G/H	1377840 EAMD-32-32-14-16X20	1345947 EAMK-A-N38-38D	1202262 EAHM-L5-M6-40
1202331 EAMM-A-N38-70A	1202337 EAMF-A-38D-70A	558001 EAMD-32-32-11-16X20	1345947 EAMK-A-N38-38D	1202288 EAHM-L5-M6-35
★ 3324111 EAMM-A-N38-87A	3319868 EAMF-A-38D-87A	558001 EAMD-32-32-11-16X20	1345947 EAMK-A-N38-38D	1202288 EAHM-L5-M6-35
★ 1972527 EAMM-A-N48-60G	1460111 EAMF-A-48C-60G/H	558001 EAMD-32-32-11-16X20	1345949 EAMK-A-N48-48C	4984529 EAHM-L5-M6-45
1456618 EAMM-A-N48-60H	1460111 EAMF-A-48C-60G/H	1377840 EAMD-32-32-14-16X20	1345949 EAMK-A-N48-48C	4984529 EAHM-L5-M6-45
★ 1258793 EAMM-A-N48-80G	1190375 EAMF-A-48C-80G	1781043 EAMD-42-40-20-16X25-U	1345949 EAMK-A-N48-48C	1201874 EAHM-L5-M6-50
1201894 EAMM-A-N48-100A	1201924 EAMF-A-48C-100A	558002 EAMD-42-40-19-16X25	1345949 EAMK-A-N48-48C	1201874 EAHM-L5-M6-50
★ 2372096 EAMM-A-N80-80G	2372201 EAMF-A-80A-80G	558004 EAMD-56-46-20-23X27	1345953 EAMK-A-N80-80A	1201712 EAHM-L5-M8-60
★ 1201695 EAMM-A-N80-120G	1190702 EAMF-A-80A-120G	1188801 EAMD-56-46-25-23X27	1345953 EAMK-A-N80-80A	1201712 EAHM-L5-M8-60
1201691 EAMM-A-N80-140A	1190796 EAMF-A-80A-140A	558005 EAMD-56-46-24-23X27	1345953 EAMK-A-N80-80A	1201751 EAHM-L5-M8-75

Festo core product range



Generally ready for shipping ex works in 24 hours

Generally ready for shipping ex works in 5 days

Data sheet

Dimensions (sample illustration)

Download CAD data → www.festo.com

ELGA-BS-...-

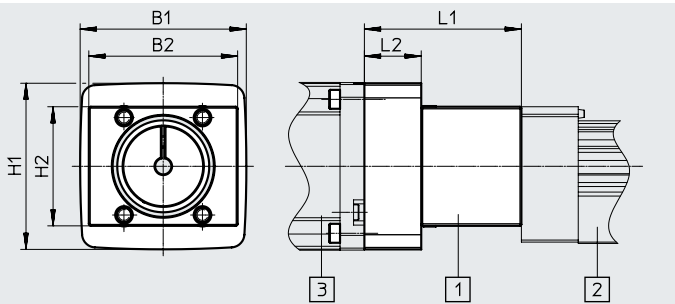



Main illustration:

- [1] Axial kit
- [2] Spindle axis
- [3] Motor

Type	B1	B2	H1	H2	L1	L2
EAMM-A-S38-40A-G2	58	55	44	44	44	7
EAMM-A-S38-40G-G2	60	55	60	44	54	17
EAMM-A-S38-40P-G2	58	55	44	44	44.7	10.7
EAMM-A-S38-42A-G2	58	55	44	44	52	15
EAMM-A-S38-50GA	62	62	62	62	59.8	22.8
EAMM-A-S38-55A-G2	55	55	55	44	48	11
EAMM-A-S38-57A-G2	56	55	56	44	48	11
EAMM-A-S38-58AA	58	58	58	44	47.6	10.6
EAMM-A-S38-60AA	60	55	60	44	48.5	11.5
EAMM-A-S38-60R	62	55	62	44	48.8	11.8
EAMM-A-S38-60RA	62	55	62	44	48.8	11.8
EAMM-A-S38-60P-G2	61.4	55	61.4	44	58	21
EAMM-A-S38-67A-G2	67	55	67	44	53	16
EAMM-A-S48-40G-G2	60	70	60	53	55	17
EAMM-A-S48-50GA	70	70	54	54	52	14
EAMM-A-S48-55A-G2	70	70	55	53	47.2	9.2
EAMM-A-S48-57A-G2	70	70	55	53	47.2	9.2
EAMM-A-S48-60G-G2	60	70	60	53	62.5	24.5
EAMM-A-S48-60H-G2	60	70	60	53	62.5	24.5
EAMM-A-S48-60P-G2	61.4	70	61.4	53	57.2	19.2
EAMM-A-S48-70A-G2	70	70	70	53	50.2	12.2
EAMM-A-S48-87A-G2	85.8	70	85.8	53	54	16
EAMM-A-S62-60G-G2	80	80	80	70	84.5	18
EAMM-A-S62-60H-G2	80	80	80	70	84.5	18
EAMM-A-S62-70A-G2	82	80	70	70	78.5	12
EAMM-A-S62-80G-G2	100	80	100	70	81	14.5
EAMM-A-S62-80P-G2	81.3	80	81.3	70	77	10.5
EAMM-A-S62-87A-G2	85.8	80	85.8	70	81.5	15
EAMM-A-S62-100A-G2	100.5	80	100.5	70	81	14.5
EAMM-A-S62-140A-G2	140	80	140	70	91	24.5
EAMM-A-S95-100A-G2	140	140	100	110	85.5	17
EAMM-A-S95-140A-G2	140	140	140	110	95.5	27

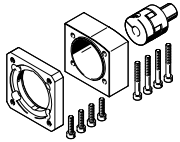
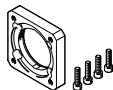
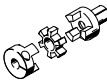
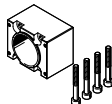
Data sheet

Ordering data – Individual components				
Axial kit	Comprising:			
	Motor flange	Coupling	Coupling housing	Screw set
				
Part no. Type	Part no. Type	Part no. Type	Part no. Type	Part no. Type
3637971 EAMM-A-S38-40A-G2	558175 EAMF-A-38B-40A	558312 EAMC-30-32-6-6	3637942 EAMK-A-S38-38A/B-G2	–
1456647 EAMM-A-S38-40G-G2	1460097 EAMF-A-38A-40G	562681 EAMC-30-32-6-10	3637942 EAMK-A-S38-38A/B-G2	567488 EAHM-L2-M5-50
★ 3637972 EAMM-A-S38-40P-G2	2219077 EAMF-A-38B-40P	533708 EAMC-30-32-6-8	3637942 EAMK-A-S38-38A/B-G2	–
★ 3637965 EAMM-A-S38-42A-G2	560691 EAMF-A-38B-42A	561333 EAMC-30-32-5-6	3637942 EAMK-A-S38-38A/B-G2	–
3637967 EAMM-A-S38-55A-G2	558176 EAMF-A-38A-55A	551003 EAMC-30-32-6-9	3637942 EAMK-A-S38-38A/B-G2	567488 EAHM-L2-M5-50
★ 3637956 EAMM-A-S38-57A-G2	560692 EAMF-A-38A-57A	551002 EAMC-30-32-6-6.35	3637942 EAMK-A-S38-38A/B-G2	567488 EAHM-L2-M5-50
★ 3637958 EAMM-A-S38-60P-G2	1987412 EAMM-A-38A-60P	1233256 EAMC-30-32-6-14	3637942 EAMK-A-S38-38A/B-G2	567489 EAHM-L2-M5-55
1456638 EAMM-A-S38-67A-G2	1490100 EAMF-A-38A-67A	551003 EAMC-30-32-6-9	3637942 EAMK-A-S38-38A/B-G2	567489 EAHM-L2-M5-55
1456650 EAMM-A-S48-40G-G2	4067069 EAMF-A-48B-40G	558029 EAMC-30-32-8-10	3637941 EAMK-A-S48-48A/B-G2	–
3637961 EAMM-A-S48-55A-G2	558177 EAMF-A-48B-55A	543423 EAMC-30-32-8-9	3637941 EAMK-A-S48-48A/B-G2	–
★ 3637963 EAMM-A-S48-57A-G2	560694 EAMF-A-48B-57A	543421 EAMC-30-32-6.35-8	3637941 EAMK-A-S48-48A/B-G2	–
2256701 EAMM-A-S48-60G-G2	558019 EAMF-A-48A-60G/H	551004 EAMC-30-32-8-11	3637941 EAMK-A-S48-48A/B-G2	567489 EAHM-L2-M5-55
1456652 EAMM-A-S48-60H-G2	558019 EAMF-A-48A-60G/H	562682 EAMC-30-32-8-14	3637941 EAMK-A-S48-48A/B-G2	567489 EAHM-L2-M5-55
★ 3637964 EAMM-A-S48-60P-G2	2220620 EAMF-A-48A-60P	562682 EAMC-30-32-8-14	3637941 EAMK-A-S48-48A/B-G2	567489 EAHM-L2-M5-55
3637957 EAMM-A-S48-70A-G2	558025 EAMF-A-48A-70A	551004 EAMC-30-32-8-11	3637941 EAMK-A-S48-48A/B-G2	567488 EAHM-L2-M5-50
★ 3637962 EAMM-A-S48-87A-G2	560695 EAMF-A-48A-87A	551004 EAMC-30-32-8-11	3637941 EAMK-A-S48-48A/B-G2	567489 EAHM-L2-M5-55
2297649 EAMM-A-S62-60G-G2	1460112 EAMF-A-62A-60G/H	525864 EAMC-40-66-11-12	3637940 EAMK-A-S62-62A/B-G2	567495 EAHM-L2-M6-90
1456654 EAMM-A-S62-60H-G2	1460112 EAMF-A-62A-60G/H	1452803 EAMC-40-66-12-14	3637940 EAMK-A-S62-62A/B-G2	567495 EAHM-L2-M6-90
3637959 EAMM-A-S62-70A-G2	558179 EAMF-A-62B-70A	558313 EAMC-42-66-11-12	3637940 EAMK-A-S62-62A/B-G2	–
1972530 EAMM-A-S62-80G-G2	2116672 EAMF-A-62B-80G	2138701 EAMC-42-50-12-20	3637940 EAMK-A-S62-62A/B-G2	–
★ 3637970 EAMM-A-S62-80P-G2	2222624 EAMF-A-62B-80P	551005 EAMC-42-50-12-19	3637940 EAMK-A-S62-62A/B-G2	–
★ 3637966 EAMM-A-S62-87A-G2	560696 EAMF-A-62B-87A	558313 EAMC-42-66-11-12	3637940 EAMK-A-S62-62A/B-G2	–
★ 3637960 EAMM-A-S62-100A-G2	558026 EAMF-A-62A-100A	551005 EAMC-42-50-12-19	3637940 EAMK-A-S62-62A/B-G2	567494 EAHM-L2-M6-80
3637969 EAMM-A-S62-140A-G2	558022 EAMF-A-62A-140A	558314 EAMC-42-50-12-24	3637940 EAMK-A-S62-62A/B-G2	567495 EAHM-L2-M6-90
3637955 EAMM-A-S95-100A-G2	558182 EAMF-A-95B-100A	558315 EAMC-56-58-19-25	3637939 EAMK-A-S95-95A/B-G2	–
3637954 EAMM-A-S95-140A-G2	558023 EAMF-A-95A-140A	558316 EAMC-56-58-24-25	3637939 EAMK-A-S95-95A/B-G2	567498 EAHM-L2-M8-100

Festo core product range



Generally ready for shipping ex works in 24 hours

Generally ready for shipping ex works in 5 days

Data sheet

Dimensions (sample illustration)

Download CAD data → www.festo.com

ELGC-TB-...

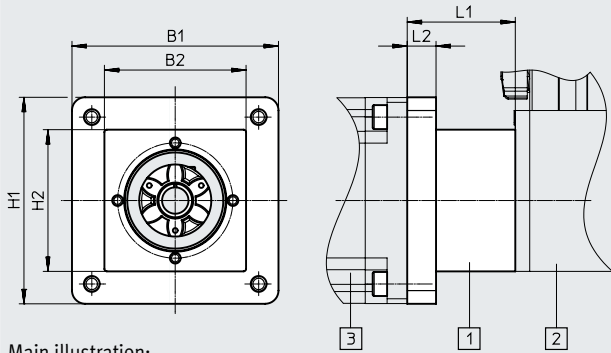

Main illustration:

- [1] Axial kit
- [2] Toothed belt axis
- [3] Motor

ELGC-BS-...

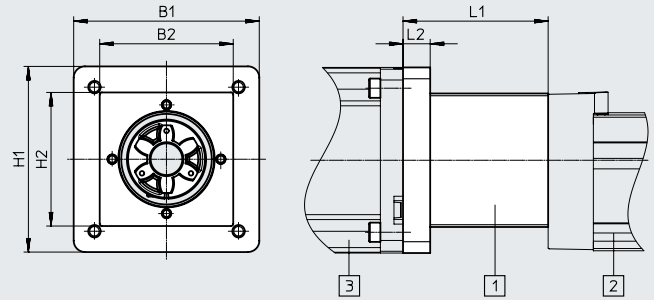

Main illustration:

- [1] Axial kit
- [2] Spindle axis
- [3] Motor

EGSC-BS-...

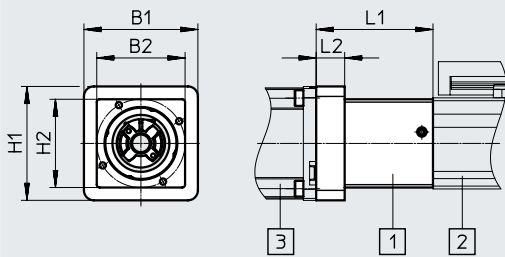

Main illustration:

- [1] Axial kit
- [2] Mini slide
- [3] Motor

EPCC

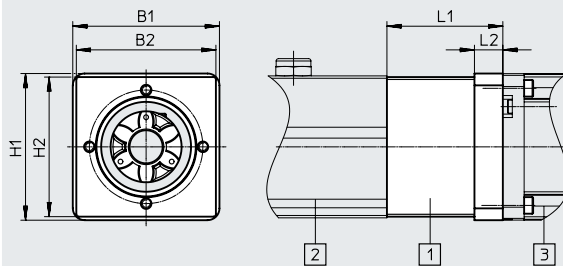

Main illustration:

- [1] Axial kit
- [2] Electric cylinder
- [3] Motor

ELGT-BS-...

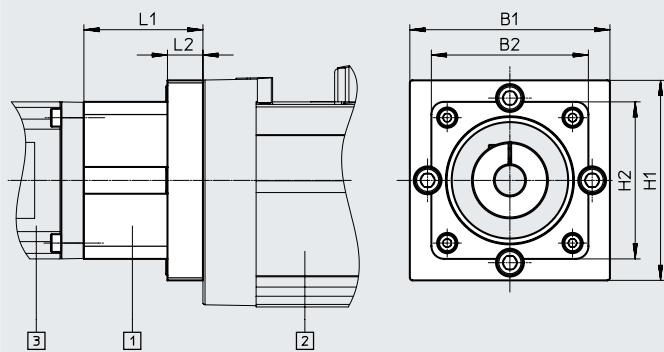

Main illustration:

- [1] Axial kit
- [2] Spindle axis
- [3] Motor

Data sheet

Dimensions and ordering data						
Type	B1	B2	H1	H2	L1 ±0.1	L2
EAMM-A-V20-28A	28	24.5	28	24.5	36.4	4
EAMM-A-V20-28AA	28	24.5	28	24.5	31.4	5.5
EAMM-A-V25-38AA	38	31	38	31	46	12
EAMM-A-V25-40P	40	31	40	31	41	10
EAMM-A-V25-40R	40	31	40	31	46	14
EAMM-A-V25-40RA	40	31	40	31	39	14
EAMM-A-V25-42A	42	31	42	31	40	6
EAMM-A-V25-42AB	42	31	42	31	36	6
EAMM-A-V32-38AA	38	44	38	44	46	11
EAMM-A-V32-40P	40	44	40	44	41	11
EAMM-A-V32-40R	40	44	40	44	46	11
EAMM-A-V32-40RA	40	44	40	44	39	11
EAMM-A-V32-42A	42	44	42	44	40	8
EAMM-A-V32-42AB	42	44	42	44	36	8
EAMM-A-V32-57A	56.4	44	56.4	44	41.5	11
EAMM-A-V32-58AA	58	44	58	44	41	17
EAMM-A-V32-60AA	60	44	60	44	42	17
EAMM-A-V32-60P	62	44	62	44	55.1	11
EAMM-A-V32-60PA	62	44	62	44	55	17
EAMM-A-V32-60RA	62	44	62	44	55	17
EAMM-A-T42-55A	59	59	59	59	43	-
EAMM-A-T42-57A	-	59	-	59	43	-
EAMM-A-T42-58AA	59	59	59	59	43	-
EAMM-A-T42-60AA	59	59	59	59	43	-
EAMM-A-T42-60AB	59	59	59	59	43	-
EAMM-A-T42-60P	-	59	-	59	48	-
EAMM-A-T42-60R	62	59	62	59	49	12
EAMM-A-T42-60RA	62	59	62	59	49	12
EAMM-A-T42-67A	67	59	67	59	43	16
EAMM-A-T42-80P	82	59	82	59	64.1	12
EAMM-A-T42-87A	86	59	86	59	45	12
EAMM-A-T46-60P	79	62	79	62	47	14
EAMM-A-T46-60R	79	62	79	62	47	14
EAMM-A-T46-60RA	79	62	79	62	47	14
EAMM-A-T46-67A	79	67	79	67	42	14
EAMM-A-T46-70A	79	79	79	79	42	-
EAMM-A-T46-70AA	79	79	79	79	47	-
EAMM-A-T46-80P	-	79	-	79	63.1	-
EAMM-A-T46-80PA	79	79	79	79	68.5	-
EAMM-A-T46-80PB	79	79	79	79	68.5	-
EAMM-A-T46-85AA	85	79	85	79	55	14
EAMM-A-T46-87A	86	79	86	79	44	12
EAMM-A-T46-100A	100	79	100	79	68.1	22

Data sheet

Dimensions (sample illustration)

Download CAD data → www.festo.com

EGC-HD-TB-...

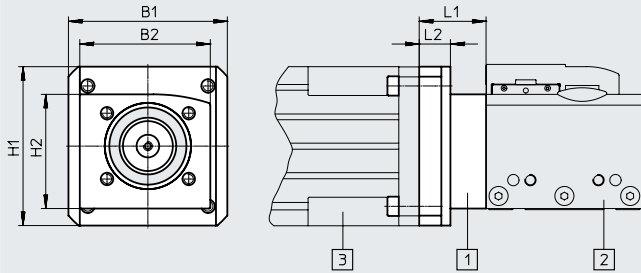

Main illustration:

- [1] Axial kit
- [2] Toothed belt axis
- [3] Motor

Type	B1	B2	H1	H2	L1	L2
EAMM-A-M43-40G	58	56	55	50	23.8	21.8
EAMM-A-M43-50GA	58	56	55	50	22.3	20.3
EAMM-A-M43-55A	58	56	55	50	17.8	15.8
EAMM-A-M43-56GA	60	56	56	50	36.9	34.9
EAMM-A-M43-60G	60	-	60	-	33	-
EAMM-A-M43-60H	60	-	60	-	33	-
EAMM-A-M43-68GA	64	56	64	50	45.9	33.9
EAMM-A-M43-70GA	73	56	73	50	33.9	31.9
EAMM-A-M43-72GA	72	56	72	50	45.9	33.9
EAMM-A-M43-70A	70	56	70	50	20.9	18.9
EAMM-A-M43-70AA	70	56	70	50	27.9	15.9
EAMM-A-M43-90R	90	56	90	50	32.9	20.9
EAMM-A-M43-92RA	90	56	90	50	37.9	25.9
EAMM-A-M48-40G	68	-	60	-	17.5	-
EAMM-A-M48-50GA	68	-	58	-	16	-
EAMM-A-M48-56GA	68	65	58	56	30.5	26.5
EAMM-A-M48-60H	66	-	60	-	26	-
EAMM-A-M48-60G	65	65	60	56	26.5	22.5
EAMM-A-M48-68GA	68	65	68	56	39.5	35.5
EAMM-A-M48-70GA	73	65	73	56	27.5	23.5
EAMM-A-M48-72GA	72	65	72	56	39.5	35.5
EAMM-A-M48-75GA	75	65	75	56	47.5	43.5
EAMM-A-M48-88A	88	65	88	56	21.5	17.5
EAMM-A-M48-84AA	96	65	96	56	31.5	27.5
EAMM-A-M48-80G	100	-	100	-	32	-
EAMM-A-M48-90GA	92	65	92	56	37.5	33.5
EAMM-A-M48-120GA	90	65	90	56	31.5	27.5

Data sheet

Dimensions (sample illustration)

Download CAD data → www.festo.com

EGC-HD-TB-...

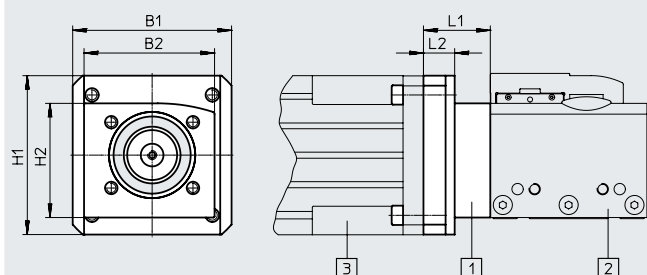

Main illustration:

- [1] Axial kit
- [2] Toothed belt axis
- [3] Motor

Type	B1	B2	H1	H2	L1	L2
EAMM-A-M80-68GA	96	92	96	82	26.5	24.5
EAMM-A-M80-75GA	96	92	96	82	35	33
EAMM-A-M80-84AA	96	92	96	82	27	25
EAMM-A-M80-80G	96	92	96	82	19	15
EAMM-A-M80-90GA	116	92	96	82	33	31
EAMM-A-M80-115GA	116	92	102	82	67	65
EAMM-A-M80-120G	124	–	124	–	34	–
EAMM-A-M80-120GA	140	92	102	82	35	33
EAMM-A-M80-120GB	140	92	122	82	39	37
EAMM-A-M80-120GC	140	92	124	82	49	47

Ordering data – Individual components

Axial kit	Comprising:		
	Motor flange	Coupling	Centring ring
Part no. Type	Part no. Type	Part no. Type	Part no. Type
1190076 EAMM-A-M43-60G	1597579 EAMF-A-43D-60G/H	558001 EAMD-32-32-11-16X20	575962 EAML-43-4-43
1456612 EAMM-A-M43-60H	1597579 EAMF-A-43D-60G/H	1377840 EAMD-32-32-14-16X20	575962 EAML-43-4-43
1456614 EAMM-A-M48-60H	1460111 EAMF-A-48C-60G/H	3420022 EAMD-42-40-14-16X25-U	558031 EAML-48-4-48
1190421 EAMM-A-M48-80G	1190375 EAMF-A-48C-80G	1781043 EAMD-42-40-20-16X25-U	558031 EAML-48-4-48
1190774 EAMM-A-M80-120G	1190702 EAMF-A-80A-120G	1781045 EAMD-56-46-25-23X27-U	1209006 EAML-80-6-80

Festo core product range



Generally ready for shipping ex works in 24 hours

Generally ready for shipping ex works in 5 days

Data sheet

Dimensions (sample illustration)

Download CAD data → www.festo.com

EGC-HD-BS...

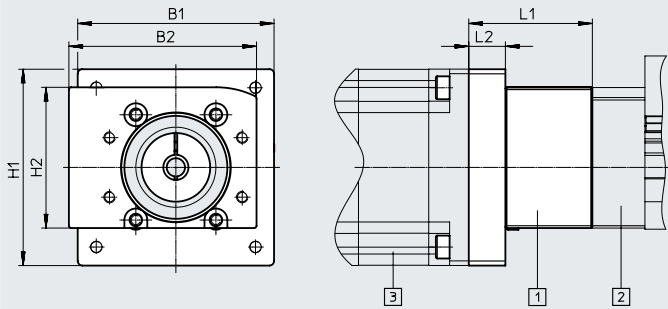



Main illustration:

- [1] Axial kit
- [2] Spindle axis
- [3] Motor

Type	B1	B2	H1	H2	L1	L2
EAMM-AS38-40A-G2	58	55	44	44	44	7
EAMM-AS38-40G-G2	60	55	60	44	54	17
EAMM-AS38-40P-G2	58	55	44	44	44.7	10.7
EAMM-AS38-42A-G2	58	55	44	44	52	15
EAMM-AS38-55A-G2	55	55	55	44	48	11
EAMM-AS38-57A-G2	56	55	56	44	48	11
EAMM-AS38-60P-G2	61.4	55	61.4	44	58	21
EAMM-AS38-67A-G2	67	55	67	44	53	16
EAMM-AS48-40G-G2	60	70	60	53	55	17
EAMM-AS48-55A-G2	70	70	55	53	47.2	9.2
EAMM-AS48-57A-G2	70	70	55	53	47.2	9.2
EAMM-AS48-60G-G2	60	70	60	53	62.5	24.5
EAMM-AS48-60H-G2	60	70	60	53	62.5	24.5
EAMM-AS48-60P-G2	61.4	70	61.4	53	57.2	19.2
EAMM-AS48-70A-G2	70	70	70	53	50.2	12.2
EAMM-AS48-87A-G2	85.8	70	85.8	53	54	16
EAMM-AS62-60G-G2	80	80	80	70	84.5	18
EAMM-AS62-60H-G2	80	80	80	70	84.5	18
EAMM-AS62-70A-G2	82	80	70	70	78.5	12
EAMM-AS62-80G-G2	100	80	100	70	81	14.5
EAMM-AS62-80P-G2	81.3	80	81.3	70	77	10.5
EAMM-AS62-87A-G2	85.8	80	85.5	70	81.5	15
EAMM-AS62-100A-G2	100.5	80	100.5	70	81	14.5
EAMM-AS62-140A-G2	140	80	140	70	91	24.5

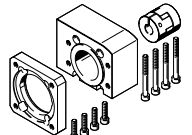
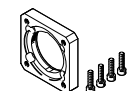
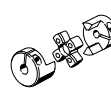
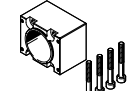
Data sheet

Ordering data – Individual components				
Axial kit	Comprising:			
	Motor flange	Coupling	Coupling housing	Screw set
				
Part no. Type	Part no. Type	Part no. Type	Part no. Type	Part no. Type
3637971 EAMM-A-S38-40A-G2	558175 EAMF-A-38B-40A	558312 EAMC-30-32-6-6	3637942 EAMK-A-S38-38A/B-G2	–
1456647 EAMM-A-S38-40G-G2	1460097 EAMF-A-38A-40G	562681 EAMC-30-32-6-10	3637942 EAMK-A-S38-38A/B-G2	567488 EAHM-L2-M5-50
★ 3637972 EAMM-A-S38-40P-G2	2219077 EAMF-A-38B-40P	533708 EAMC-30-32-6-8	3637942 EAMK-A-S38-38A/B-G2	–
★ 3637965 EAMM-A-S38-42A-G2	560691 EAMF-A-38B-42A	561333 EAMC-30-32-5-6	3637942 EAMK-A-S38-38A/B-G2	–
3637967 EAMM-A-S38-55A-G2	558176 EAMF-A-38A-55A	551003 EAMC-30-32-6-9	3637942 EAMK-A-S38-38A/B-G2	567488 EAHM-L2-M5-50
★ 3637956 EAMM-A-S38-57A-G2	560692 EAMF-A-38A-57A	551002 EAMC-30-32-6-6.35	3637942 EAMK-A-S38-38A/B-G2	567488 EAHM-L2-M5-50
★ 3637958 EAMM-A-S38-60P-G2	1987412 EAMF-A-38A-60P	1233256 EAMC-30-32-6-14	3637942 EAMK-A-S38-38A/B-G2	567489 EAHM-L2-M5-55
1456638 EAMM-A-S38-67A-G2	1490100 EAMF-A-38A-67A	551003 EAMC-30-32-6-9	3637942 EAMK-A-S38-38A/B-G2	567489 EAHM-L2-M5-55
1456650 EAMM-A-S48-40G-G2	4067069 EAMF-A-48B-40G	558029 EAMC-30-32-8-10	3637941 EAMK-A-S48-48A/B-G2	–
3637961 EAMM-A-S48-55A-G2	558177 EAMF-A-48B-55A	543423 EAMC-30-32-8-9	3637941 EAMK-A-S48-48A/B-G2	–
★ 3637963 EAMM-A-S48-57A-G2	560694 EAMF-A-48B-57A	543421 EAMC-30-32-6.35-8	3637941 EAMK-A-S48-48A/B-G2	–
2256701 EAMM-A-S48-60G-G2	558019 EAMF-A-48A-60G/H	551004 EAMC-30-32-8-11	3637941 EAMK-A-S48-48A/B-G2	567489 EAHM-L2-M5-55
1456652 EAMM-A-S48-60H-G2	558019 EAMF-A-48A-60G/H	562682 EAMC-30-32-8-14	3637941 EAMK-A-S48-48A/B-G2	567489 EAHM-L2-M5-55
★ 3637964 EAMM-A-S48-60P-G2	2220620 EAMF-A-48A-60P	562682 EAMC-30-32-8-14	3637941 EAMK-A-S48-48A/B-G2	567489 EAHM-L2-M5-55
3637957 EAMM-A-S48-70A-G2	558025 EAMF-A-48A-70A	551004 EAMC-30-32-8-11	3637941 EAMK-A-S48-48A/B-G2	567488 EAHM-L2-M5-50
★ 3637962 EAMM-A-S48-87A-G2	560695 EAMF-A-48A-87A	551004 EAMC-30-32-8-11	3637941 EAMK-A-S48-48A/B-G2	567489 EAHM-L2-M5-55
2297649 EAMM-A-S62-60G-G2	1460112 EAMF-A-62A-60G/H	525864 EAMC-40-66-11-12	3637940 EAMK-A-S62-62A/B-G2	567495 EAHM-L2-M6-90
1456654 EAMM-A-S62-60H-G2	1460112 EAMF-A-62A-60G/H	1452803 EAMC-40-66-12-14	3637940 EAMK-A-S62-62A/B-G2	567495 EAHM-L2-M6-90
3637959 EAMM-A-S62-70A-G2	558179 EAMF-A-62B-70A	558313 EAMC-42-66-11-12	3637940 EAMK-A-S62-62A/B-G2	–
1972530 EAMM-A-S62-80G-G2	2116672 EAMF-A-62B-80G	2138701 EAMC-42-50-12-20	3637940 EAMK-A-S62-62A/B-G2	–
★ 3637970 EAMM-A-S62-80P-G2	2222624 EAMF-A-62B-80P	551005 EAMC-42-50-12-19	3637940 EAMK-A-S62-62A/B-G2	–
★ 3637966 EAMM-A-S62-87A-G2	560696 EAMF-A-62B-87A	558313 EAMC-42-66-11-12	3637940 EAMK-A-S62-62A/B-G2	–
★ 3637960 EAMM-A-S62-100A-G2	558026 EAMF-A-62A-100A	551005 EAMC-42-50-12-19	3637940 EAMK-A-S62-62A/B-G2	567494 EAHM-L2-M6-80
3637969 EAMM-A-S62-140A-G2	558022 EAMF-A-62A-140A	558314 EAMC-42-50-12-24	3637940 EAMK-A-S62-62A/B-G2	567495 EAHM-L2-M6-90

Festo core product range



Generally ready for shipping ex works in 24 hours

Generally ready for shipping ex works in 5 days

Data sheet

Dimensions (sample illustration)

Download CAD data → www.festo.com

EGSK...

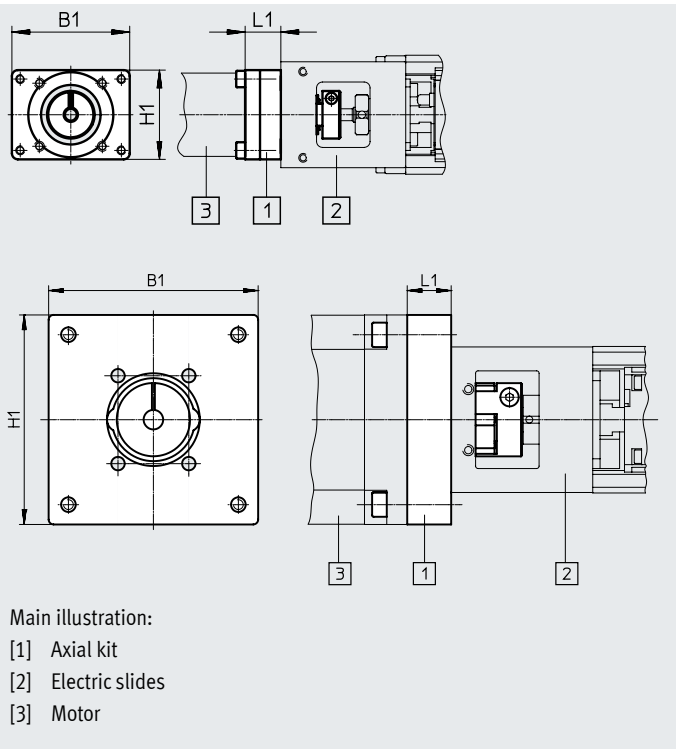

Type	B1	H1	L1
EAMM-A-P3-28D-28A	30	30	15
EAMM-A-P3-28D-40P	39.7	39.7	14.5
EAMM-A-P4-28B-28A	39.6	30	12
EAMM-A-P4-28B-38AA	38	38	17.5
EAMM-A-P4-28B-40A	40	40	8.3
EAMM-A-P4-28B-40P	39.7	39.7	12.5
EAMM-A-P4-28B-40R	40	40	17.5
EAMM-A-P4-28B-40RA	40	40	10.5
EAMM-A-P4-28B-42A	42	42	16.5
EAMM-A-P5-28B-28A	39.6	30	12
EAMM-A-P5-28B-38AA	38	38	17.5
EAMM-A-P5-28B-40A	40	40	8.3
EAMM-A-P5-28B-40P	39.7	39.7	12.5
EAMM-A-P5-28B-40R	40	40	17.5
EAMM-A-P5-28B-40RA	40	40	10.5
EAMM-A-P5-28B-42A	42	42	16.5
EAMM-A-P6-38A-40A	50	50	9
EAMM-A-P6-38A-40G	60	60	17
EAMM-A-P6-38A-40P	50	50	10.7
EAMM-A-P6-38A-42A	55	55	15
EAMM-A-P6-38A-55A	55	55	11
EAMM-A-P6-38A-57A	56	56	11
EAMM-A-P6-38A-58AA	58	58	10.6
EAMM-A-P6-38A-60P	61.4	61.4	21
EAMM-A-P6-38A-60R	61.4	61.4	21
EAMM-A-P6-38A-60RA	61.4	61.4	21
EAMM-A-P6-38A-67A	67	67	16
EAMM-A-P8-38A-40A	50	50	9
EAMM-A-P8-38A-40G	60	60	17
EAMM-A-P8-38A-40P	50	50	10.7
EAMM-A-P8-38A-42A	55	55	15
EAMM-A-P8-38A-55A	55	55	11
EAMM-A-P8-38A-57A	56	56	11
EAMM-A-P8-38A-58AA	58	58	10.6
EAMM-A-P8-38A-60AA	60	60	11.5
EAMM-A-P8-38A-60P	61.4	61.4	21
EAMM-A-P8-38A-60R	62	62	11.8
EAMM-A-P8-38A-60RA	62	62	11.8
EAMM-A-P8-38A-67A	67	67	16
EAMM-A-P8-38A-70A	70	70	13.8
EAMM-A-P8-38A-70AA	70	70	13.75
EAMM-A-P8-38A-87A	85.8	85.8	18
EAMM-A-P10-38A-40G	60	60	17
EAMM-A-P10-38A-55A	55	55	11
EAMM-A-P10-38A-57A	56	56	11
EAMM-A-P10-38A-60P	61.4	61.4	21
EAMM-A-P10-38A-67A	67	67	16
EAMM-A-P10-38A-70A	70	70	13.8
EAMM-A-P10-38A-87A	85.8	85.8	18

Data sheet

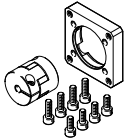
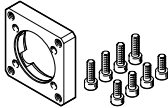
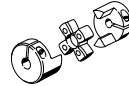
Ordering data – Individual components		
Axial kit	Comprising:	
	Motor flange	Coupling
		
Part no. Type	Part no. Type	Part no. Type
1703478 EAMM-A-P3-28D-28A	1087613 EAMF-A-28D-28A	562672 EAMC-16-20-3-5
1982886 EAMM-A-P3-28D-40P	1982014 EAMF-A-28D-40P	2310368 EAMC-16-20-3-8
1731466 EAMM-A-P4-28B-28A	1704476 EAMF-A-28B-28A	562674 EAMC-16-20-4-5
1983071 EAMM-A-P4-28B-40P	1976704 EAMF-A-28B-40P	562675 EAMC-16-20-4-8
562637 EAMM-A-P4-28B-40A	552163 EAMF-A-28B-40A	562673 EAMC-16-20-4-6
562636 EAMM-A-P4-28B-42A	552164 EAMF-A-28B-42A	562674 EAMC-16-20-4-5
1731474 EAMM-A-P5-28B-28A	1704476 EAMF-A-28B-28A	562676 EAMC-16-20-5-5
562641 EAMM-A-P5-28B-40A	552163 EAMF-A-28B-40A	543419 EAMC-16-20-5-6
1983122 EAMM-A-P5-28B-40P	1976704 EAMF-A-28B-40P	562677 EAMC-16-20-5-8
562640 EAMM-A-P5-28B-42A	552164 EAMF-A-28B-42A	562676 EAMC-16-20-5-5
562646 EAMM-A-P6-38A-40A	562667 EAMF-A-38A-40A	558312 EAMC-30-32-6-6
2297645 EAMM-A-P6-38A-40G	1460097 EAMF-A-38A-40G	562681 EAMC-30-32-6-10
1983450 EAMM-A-P6-38A-40P	1984478 EAMF-A-38A-40P	533708 EAMC-30-32-6-8
562644 EAMM-A-P6-38A-42A	562668 EAMF-A-38A-42A	561333 EAMC-30-32-5-6
562647 EAMM-A-P6-38A-55A	558176 EAMF-A-38A-55A	551003 EAMC-30-32-6-9
562645 EAMM-A-P6-38A-57A	560692 EAMF-A-38A-57A	551002 EAMC-30-32-6-6.35
2264375 EAMM-A-P6-38A-60P	1987412 EAMF-A-38A-60P	1233256 EAMC-30-32-6-14
2297641 EAMM-A-P6-38A-67A	1490100 EAMF-A-38A-67A	551003 EAMC-30-32-6-9

Data sheet

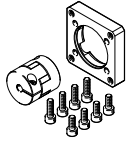
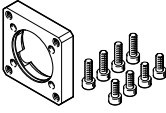
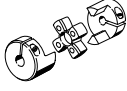
Ordering data – Individual components		
Axial kit	Comprising:	
	Motor flange	Coupling
		
Part no. Type	Part no. Type	Part no. Type
562652 EAMM-A-P8-38A-40A	562667 EAMF-A-38A-40A	533708 EAMC-30-32-6-8
2297646 EAMM-A-P8-38A-40G	1460097 EAMF-A-38A-40G	558029 EAMC-30-32-8-10
1986292 EAMM-A-P8-38A-40P	1984478 EAMF-A-38A-40P	543422 EAMC-30-32-8-8
562650 EAMM-A-P8-38A-42A	562668 EAMF-A-38A-42A	562678 EAMC-30-32-5-8
562653 EAMM-A-P8-38A-55A	558176 EAMF-A-38A-55A	543423 EAMC-30-32-8-9
562651 EAMM-A-P8-38A-57A	560692 EAMF-A-38A-57A	543421 EAMC-30-32-6.35-8
1987308 EAMM-A-P8-38A-60P	1987412 EAMF-A-38A-60P	562682 EAMC-30-32-8-14
2297643 EAMM-A-P8-38A-67A	1490100 EAMF-A-38A-67A	543423 EAMC-30-32-8-9
564996 EAMM-A-P8-38A-70A	558018 EAMF-A-38A-70A	551004 EAMC-30-32-8-11
564998 EAMM-A-P8-38A-87A	560693 EAMF-A-38A-87A	551004 EAMC-30-32-8-11
2297648 EAMM-A-P10-38A-40G	1460097 EAMF-A-38A-40G	2310372 EAMC-30-32-10-10
562659 EAMM-A-P10-38A-55A	558176 EAMF-A-38A-55A	562680 EAMC-30-32-9-10
562658 EAMM-A-P10-38A-57A	560692 EAMF-A-38A-57A	562679 EAMC-30-32-6.35-10
2036017 EAMM-A-P10-38A-60P	1987412 EAMF-A-38A-60P	562683 EAMC-30-32-10-14
2297644 EAMM-A-P10-38A-67A	1490100 EAMF-A-38A-67A	562680 EAMC-30-32-9-10
564997 EAMM-A-P10-38A-70A	558018 EAMF-A-38A-70A	565008 EAMC-30-32-10-11
564999 EAMM-A-P10-38A-87A	560693 EAMF-A-38A-87A	565008 EAMC-30-32-10-11

Data sheet

Dimensions (sample illustration)

Download CAD data → www.festo.com

ELGG-..., ELGR-...

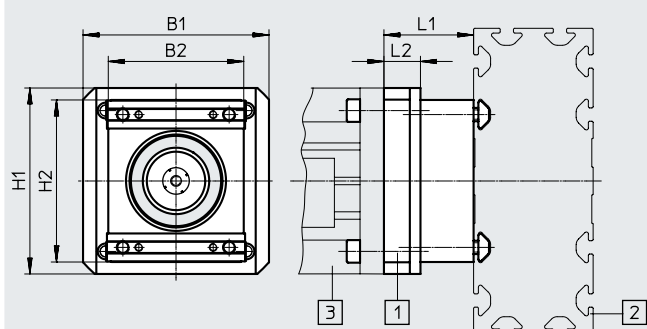



Main illustration:

- [1] Axial kit
- [2] Toothed belt axis
- [3] Motor

Type	B1	B2	H1	H2	L1	L2
EAMM-A-R27-40G	55	44.5	55	48.3	26	11
EAMM-A-R27-55A	55	44.5	55	48.3	26	11
EAMM-A-R27-57A	56	44.5	56	48.3	26	11
EAMM-A-R27-67A	67	44.5	67	48.3	31	16
EAMM-A-R38-40G	60	51	60	61	37	17
EAMM-A-R38-57A	56	–	–	–	31	–
EAMM-A-R38-60G	60	51	60	61	46	26
EAMM-A-R38-60H	60	51	60	61	46	26
EAMM-A-R38-60P	61.4	51	61.4	61	41	21
EAMM-A-R38-70A	70	51	70	61	33.8	13.8
EAMM-A-R38-87A	85.8	51	85.8	61	38	18
EAMM-A-R48-60G	60	55	60	81	52.5	24.5
EAMM-A-R48-60H	60	55	60	51	52.5	24.5
EAMM-A-R48-70A	70	–	–	–	40.2	–
EAMM-A-R48-80P	81.3	55	81.3	81	54	26
EAMM-A-R48-87A	85.5	55	85.5	81	44	16
EAMM-A-R48-100A	100.5	55	100.5	81	59	31

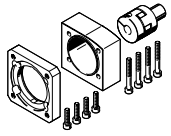
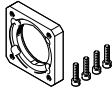
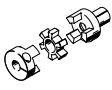
Data sheet

Ordering data – Individual components			
Axial kit	Comprising:		
	Motor flange	Coupling	Coupling housing
			
Part no. Type	Part no. Type	Part no. Type	Part no. Type
1456622 EAMM-A-R27-40G	1460097 EAMF-A-38A-40G	557998 EAMD-19-15-10-8X10	1133397 EAMK-A-R27-38A
1133400 EAMM-A-R27-55A	558176 EAMF-A-38A-55A	557999 EAMD-19-15-9-8X10	1133397 EAMK-A-R27-38A
★ 1133403 EAMM-A-R27-57A	560692 EAMF-A-38A-57A	561292 EAMD-16-15-6.35-8X10	1133397 EAMK-A-R27-38A
1456619 EAMM-A-R27-67A	1490100 EAMF-A-38A-67A	557999 EAMD-19-15-9-8X10	1133397 EAMK-A-R27-38A
1456623 EAMM-A-R38-40G	1460097 EAMF-A-38A-40G	1453860 EAMD-25-22-10-10X12	1133398 EAMK-A-R38-38A
★ 1578138 EAMM-A-R38-57A	560692 EAMF-A-38A-57A	561293 EAMD-25-22-6.35-10X12	1133398 EAMK-A-R38-38A
2310075 EAMM-A-R38-60G	558017 EAMF-A-38A-60G/H	558000 EAMD-25-22-11-10X12	1133398 EAMK-A-R38-38A
1456630 EAMM-A-R38-60H	558017 EAMF-A-38A-60G/H	1453861 EAMD-28-22-14-10X12	1133398 EAMK-A-R38-38A
★ 2224996 EAMM-A-R38-60P	1987412 EAMF-A-38A-60P	1453861 EAMD-28-22-14-10X12	1133398 EAMK-A-R38-38A
1133401 EAMM-A-R38-70A	558018 EAMF-A-38A-70A	558000 EAMD-25-22-11-10X12	1133398 EAMK-A-R38-38A
★ 1133404 EAMM-A-R38-87A	560693 EAMF-A-38A-87A	558000 EAMD-25-22-11-10X12	1133398 EAMK-A-R38-38A
2374780 EAMM-A-R48-60G	558019 EAMF-A-48A-60G/H	558001 EAMD-32-32-11-16X20	1133399 EAMK-A-R48-48A
1456633 EAMM-A-R48-60H	558019 EAMF-A-48A-60G/H	1377840 EAMD-32-32-14-16X20	1133399 EAMK-A-R48-48A
1578139 EAMM-A-R48-70A	558025 EAMF-A-48A-70A	558001 EAMD-32-32-11-16X20	1133399 EAMK-A-R48-48A
★ 2225090 EAMM-A-R48-80P	2043427 EAMF-A-48A-80P	558002 EAMD-42-40-19-16X25	1133399 EAMK-A-R48-48A
★ 1133405 EAMM-A-R48-87A	560695 EAMF-A-48A-87A	558001 EAMD-32-32-11-16X20	1133399 EAMK-A-R48-48A
★ 1133402 EAMM-A-R48-100A	558020 EAMF-A-48A-100A	558002 EAMD-42-40-19-16X25	1133399 EAMK-A-R48-48A

Festo core product range



Generally ready for shipping ex works in 24 hours



Generally ready for shipping ex works in 5 days

Accessories

Seal set

Contains paint-wetting impairment substances
RoHS-compliant

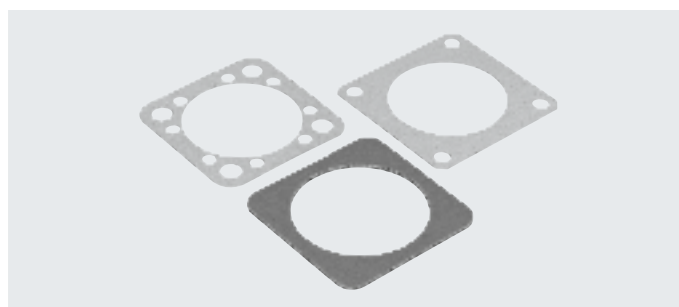

Ordering data						
Type	For axial kit	For electric cylinder	Ambient temperature [°C]	CRC ¹⁾	Part no.	Type
EADS-F-D32-40A	EAMM-A-D32-40A	ESBF, EGSL, ERMB, ERMH	-25 ... +60	4	1561526	EADS-F-D32-40A
EADS-F-D32-40G	EAMM-A-D32-40G				2253500	EADS-F-D32-40G
EADS-F-D32-40P	EAMM-A-D32-40P				2207219	EADS-F-D32-40P
EADS-F-D32-60G/H	EAMM-A-D32-60G EAMM-A-D32-60H				8022150	EADS-F-D32-60G/H
EADS-F-D32-60P	EAMM-A-D32-60P				2234012	EADS-F-D32-60P
EADS-F-D32-67A	EAMM-A-D32-67A				2253501	EADS-F-D32-67A
EADS-F-D32-42A	EAMM-A-D32-42A				1561527	EADS-F-D32-42A
EADS-F-D32-55A	EAMM-A-D32-55A				1561528	EADS-F-D32-55A
EADS-F-D32-57A	EAMM-A-D32-57A				1561529	EADS-F-D32-57A
EADS-F-D40-40G	EAMM-A-D40-40G				2253502	EADS-F-D40-40G
EADS-F-D40-55A	EAMM-A-D40-55A				1561530	EADS-F-D40-55A
EADS-F-D40-57A	EAMM-A-D40-57A				1561531	EADS-F-D40-57A
EADS-F-D40-60G/H	EAMM-A-D40-60G EAMM-A-D40-60H				2253503	EADS-F-D40-60G/H
EADS-F-D40-60P	EAMM-A-D40-60P				2151545	EADS-F-D40-60P
EADS-F-D40-67A	EAMM-A-D40-67A				2253504	EADS-F-D40-67A
EADS-F-D40-70A	EAMM-A-D40-70A				1561532	EADS-F-D40-70A
EADS-F-D40-87A	EAMM-A-D40-87A				1561533	EADS-F-D40-87A
EADS-F-D50-60G/H	EAMM-A-D50-60G EAMM-A-D50-60H				2733792	EADS-F-D50-60G/H
EADS-F-D50-70A	EAMM-A-D50-70A				2733789	EADS-F-D50-70A
EADS-F-D50-80G	EAMM-A-D50-80G				2733793	EADS-F-D50-80G
EADS-F-D50-80P	EAMM-A-D50-80P				2733791	EADS-F-D50-80P
EADS-F-D50-87A	EAMM-A-D50-87A				2733788	EADS-F-D50-87A
EADS-F-D50-100A	EAMM-A-D50-100A				2733790	EADS-F-D50-100A
EADS-F-D60-70A	EAMM-A-D60-70A				8022145	EADS-F-D60-70A
EADS-F-D60-80G	EAMM-A-D60-80G				8022146	EADS-F-D60-80G
EADS-F-D60-60G/H	EAMM-A-D60-60G EAMM-A-D60-60H				2253505	EADS-F-D60-60G/H
EADS-F-D60-80P	EAMM-A-D60-80P				2218523	EADS-F-D60-80P
EADS-F-D60-87A	EAMM-A-D60-87A				1561536	EADS-F-D60-87A
EADS-F-D60-100A	EAMM-A-D60-100A				2253507	EADS-F-D60-100A
EADS-F-D80-80G	EAMM-A-D80-80G	8022147	EADS-F-D80-80G			
EADS-F-D80-100A	EAMM-A-D80-100A	1593617	EADS-F-D80-100A			
EADS-F-D80-140A	EAMM-A-D80-140A	1593671	EADS-F-D80-140A			
EADS-F-D100-100A	EAMM-A-D100-100A	3356966	EADS-F-D100-100A			
EADS-F-D100-120G	EAMM-A-D100-120G	8022148	EADS-F-D100-120G			
EADS-F-D100-140A	EAMM-A-D100-140A	1593991	EADS-F-D100-140A			

1) Corrosion resistance class CRC 4 to Festo standard FN 940070

Particularly high corrosion stress. Outdoor exposure under extreme corrosive conditions. Parts exposed to aggressive media, e.g. in the chemical or food industries. Such applications may need to be safeguarded by means of special testing (→ also FN 940082), using appropriate media.